

IP2266EN • 2020-11-20

**Ditec**

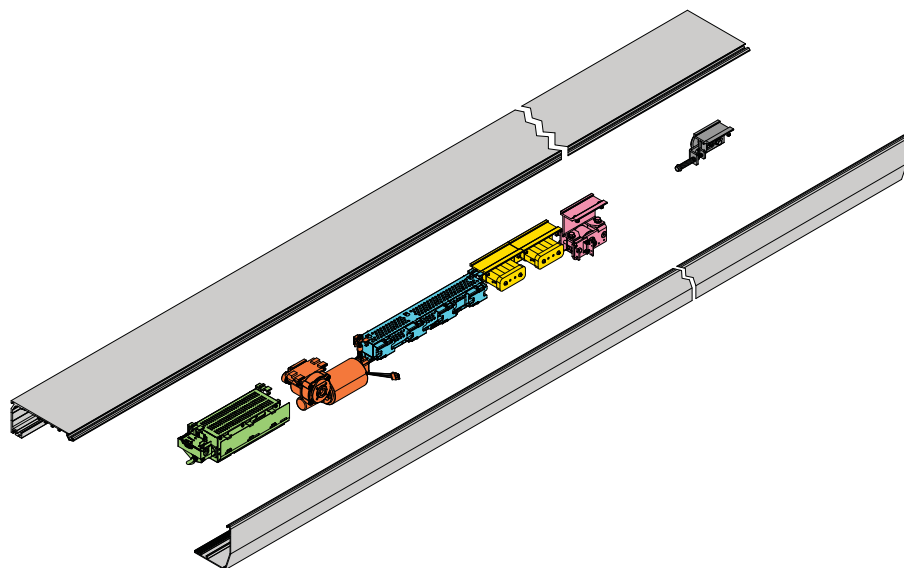

**Ditec DAS200** Technical manual  
**DAS200HD-DAS200RF-DAS200RG**  
Sliding doors automation  
(Original instructions)

# Contents

	Subject	Page
<b>1.</b>	<b>General safety precautions</b>	3
	Declaration of incorporation of partly completed machinery	4
<b>2.</b>	<b>Technical data</b>	5
<b>3.</b>	<b>Standard installation</b>	6
<b>4.</b>	<b>Main components</b>	7
<b>5.</b>	<b>Installing the automation</b>	8
5.1	Installing / Removing the cover	8
5.2	Installation/removal of the cover if installed side presence sensor	9
<b>6.</b>	<b>Examples of installation</b>	10
6.1	Example using supplied wing anchoring brackets	10
6.2	Examples with DAS11M8	11
6.3	Examples with DAS18M8	12
6.4	Example with DAS35M8	13
6.5	Example with DAS40M8	14
6.6	Example with ACV	14
<b>7.</b>	<b>Preparation of the glass door wing</b>	15
7.1	Installing and adjusting the door wings	16
7.2	Installing the floor guides	18
7.3	Belt stop installation	18
7.4	Checking and adjusting the belt tension	19
7.5	Sensor positioning on the cover	19
7.6	External sensor cable fixing	19
<b>8.</b>	<b>Electrical connections</b>	20
8.1	Electrical connections	21
8.2	Control panel commands	23
8.2.1	Commands	23
8.3	DAS902MP plus module (optional)	25
8.4	DAS902MP commands	26
<b>9.</b>	<b>Adjustment and selection of control functions</b>	28
9.1	Display test	29
9.2	Status indication on the display	29
<b>10.</b>	<b>Start up</b>	30
<b>11.</b>	<b>Parameters</b>	33
11.1	Configuration parameters according to function	33
11.2	Main control board parameters	36
<b>12.</b>	<b>Example of connection</b>	48
12.1	Combined opening and safety sensor + safety sensor on opening	48
12.2	Interconnection of operators	50
12.2.1	Interconnection cable	50
12.2.2	Hardware configuration for interconnection	50
12.2.3	Parameter configuration for interconnection	51
12.3	Operation mode selector (OMS) functionality	51
12.4	Synchronization	52
12.5	Interlock	52
<b>13.</b>	<b>Troubleshooting</b>	54
13.1	Active error indication	55
<b>14.</b>	<b>Routine maintenance plan</b>	59

## Key



This symbol indicates instructions or notes regarding safety, to which special attention must be paid.



This symbol indicates useful information for the correct functioning of the product.

# 1. General safety precautions



Failure to respect the information given in this manual may cause personal injury or damage to the device.  
Keep these instructions for future reference

This assembly and installation manual is intended exclusively for the use of qualified personnel. Installation, electrical connections and adjustments must be performed by qualified personnel, in accordance with Good Working Methods and in compliance with the current regulations.

Read the instructions carefully before installing the product.

Incorrect installation could be dangerous.



The packaging materials (plastic, polystyrene, etc.) should not be discarded in the environment or left within reach of children, as they are a potential source of danger.

Before installing the product, make sure it is in perfect condition.

Do not install the product in explosive areas and atmospheres: the presence of inflammable gas or fumes represents a serious safety hazard.

Before installing the motorisation device, make all the necessary structural modifications to create safety clearance and to guard or isolate all the crushing, shearing, trapping and general hazardous areas.

Make sure the existing structure is up to standard in terms of strength and stability. The motorisation device manufacturer is not responsible for failure to observe Good Working Methods when building the frames to be motorised, or for any deformations during use.

The safety devices (photocells, safety edges, emergency stops, etc.) must be installed taking into account the applicable laws and directives, Good Working Methods, installation premises, system operating logic and the forces developed by the motorised door or gate.

The safety devices must protect against crushing, cutting, trapping and general danger areas of the motorised door or gate.

Display the signs required by law to identify hazardous areas.

Each installation must bear a visible indication of the data identifying the motorised door or gate.

When necessary, connect the motorised door or gate to an effective earthing system that complies with the current safety standards.



During installation, maintenance and repair operations, cut off the power supply before opening the cover to access the electrical parts.

The automation protection casing must be removed by qualified personnel only.



The electronic parts must be handled using earthed antistatic conductive arms. The manufacturer of the motorisation device declines all responsibility if component parts not compatible with safe and correct operation are fitted.

Only use original spare parts when repairing or replacing products.

The installer must supply all information concerning the automatic, manual and emergency operation of the motorised door or gate, and must provide the user with the operating instructions.

# Declaration of incorporation of partly completed machinery

We:

Entrematic Group AB  
Lodjursgatan 10  
SE-261 44 Landskrona  
Sweden

declare under our responsibility that the following types of equipment:

Ditec DAS200, Ditec DAS200HD, Ditec DAS200RF, Ditec DAS200RG comply with the following directives:

2014/30/EU 2006/42/EC	Electromagnetic Compatibility Directive (EMCD) Machinery Directive (MD) for the following essential health and safety requirements: 1.1.2, 1.2.1, 1.2.2, 1.2.3, 1.2.4.2, 1.2.6, 1.3.9, 1.4.3, 1.7.2, 1.7.4, 1.7.4.1, 1.7.4.2
2011/65/EU	on the restriction of the use of certain hazardous substances in electrical and electronic equipment (RoHS)

Technical documentation for safe integration supplied.  
Harmonised European standards which have been applied:

EN 60335 -1:2012+A13:2017	EN ISO 13849 -1:2015	EN 61000 -6-2:2005
EN 60335-2-103:2015	EN 16005:2012/AC:2015	EN 61000 -6-3:2007+A1:2011

Other standards or technical specifications, which have been applied:

IEC 60335-1: 2010 ed.5	IEC 60335-2-103:2006+A1:2010	AutSchR: 1997
DIN 18650-1:2010	DIN 18650-2:2010	

EC type examination or certificate issued by a notified or competent body (for full address please contact Entrematic Group AB) concerning the equipment:

B 085479 011( Ditec DAS200)  
B 085479 013( Ditec DAS200HD, Ditec DAS200RG)  
B 085479 012( Ditec DAS200RF)

The production process aims to guarantee that the equipment complies with the technical documentation.

The production process is regularly assessed by an independent body.

The equipment must not be put into service until the final door system installed has been declared compliant with the Machinery Directive 2006/42/EC by the installer.

Person in charge of technical data sheet:

Matteo Fino E-mail: [matteo.fino@entrematic.com](mailto:matteo.fino@entrematic.com)

Entrematic Group AB  
Lodjursgatan 10  
SE-261 44 Landskrona  
Sweden

Place	Date	Signature	Position
Landskrona	2020-11-20	Matteo Fino	Entrance Automation President



## 2. Technical data

	Ditec DAS200	Ditec DAS200HD Ditec DAS200RF	Ditec DAS200RG
Power supply	110V~ / 240V~ 50/60Hz	110V~ / 240V~ 50/60Hz	110V~ / 240V~ 50/60Hz
Power supply rated power (PS)	75W	150W	150W
Max Opening speed (2 door wings)	1,6m/s	1,6m/s	1,6m/s
Maximum load	120kg (1 wing) 200kg (2 wings)	150kg (1 wing) DAS200HD 280kg (2 wings) DAS200RF 240kg (2 wings)	150kg (1 wing) 280kg (2 wings)
Intermittence	S3=100%	S3=100%	S3=100%
Temperature	 -20°C +50°C	 -20°C +50°C	 -20°C +50°C
Degree of protection	IP20 (FOR INTERNAL USE ONLY)	IP20 (FOR INTERNAL USE ONLY)	IP20 (FOR INTERNAL USE ONLY)
Control panel (MCU/MCU-ER)	1DAS20QE	1DAS20HDQE	1DAS20RGQE
Accessories power supply	24V  0,64A	24V  1A	24V  1A
Durability test	1.000.000 cycles	1.000.000 cycles	1.000.000 cycles

TYPE OF USE	Ditec DAS200	Ditec DAS200HD	Ditec DAS200RF	Ditec DAS200RG
Sliding door automation	X	X		
Escape route with break-out system	X	X		
Escape route with rubber band opening system			X	
Escape route with redundant system				X

### 3. Standard installation

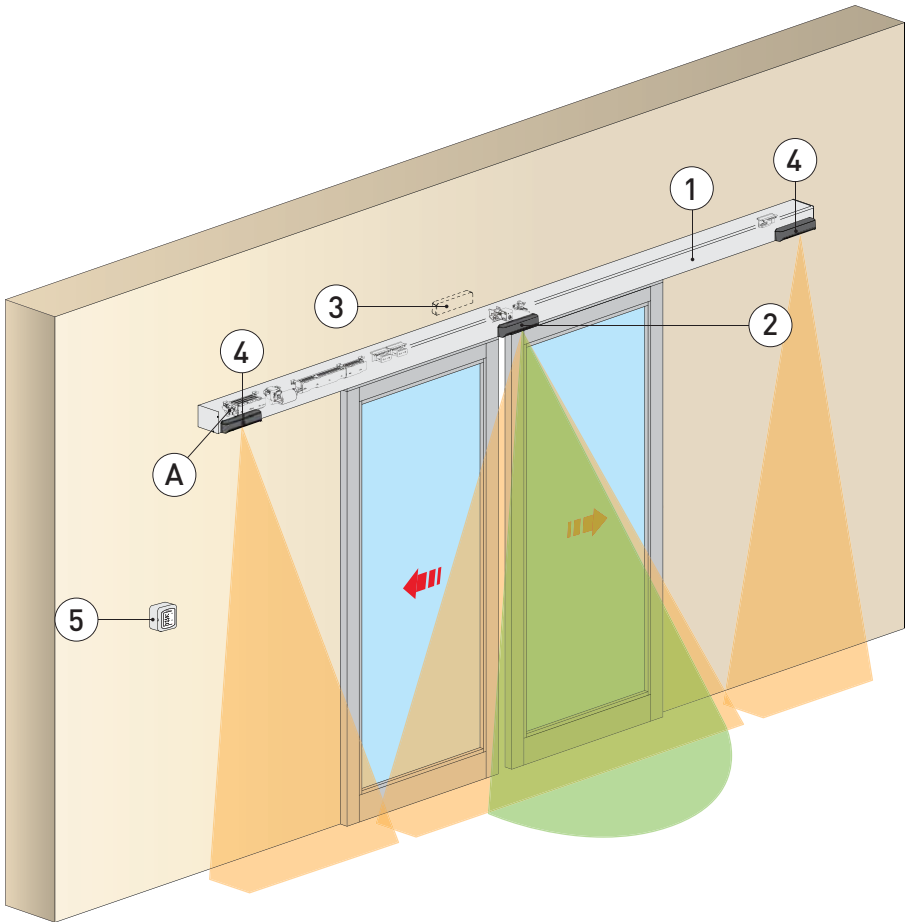

Ref.	Description
1	Automation for sliding doors
2	Combined opening and safe closing sensor
3	Combined opening and safe closing sensor
4	Safe opening sensor
5	Program selector
A	Connect the power supply cable to a type-approved omnipolar switch with category III insulation and a contact opening distance of at least 3 mm. The connections to the mains and low voltage wires must be made on an independent channel separated from the connections to the command and safety devices (SELV = Safety Extra Low Voltage).

## 4. Main components

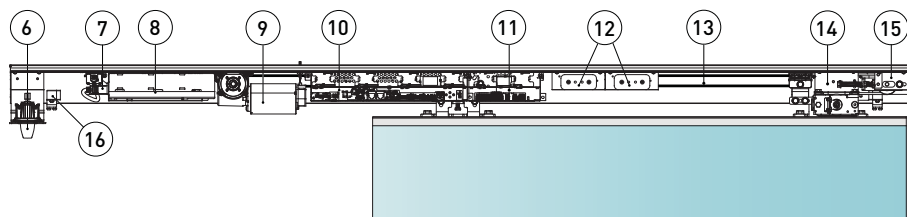

Ref.	Code	Description
6	DASLOKSB	Built-in manual release device (optional)
7	-	Mains power supply
8	1DAS20AL 1DAS20HAL	75W power supply unit (PS) 150W power supply unit (PS)
9	1DAS20MR 1DAS20HMR 1DAS20RGMR	DAS200 gearmotor DAS200HD gearmotor DAS200RG gearmotor
10	1DAS20QE 1DAS20HDQE 1DAS20RGQE	DAS200 control panel (MCU) DAS200HD-DAS200RF control panel (MCU) DAS200RG control panel (MCU-ER)
11	DAS902MP	DAS902MP plus module
12	DAS901BAT1 DAS902BAT2	12V batteries (set parameter 43= 05) 24V batteries (the fuse in the cable harness is T10A)
13	DAS802B50	Drive belt
14	DAS802LOK DAS802LOKA DAS802LOKB	Standard lock. Locked with power - LD Anti-panic lock. Locked without power - LDP Bi-stable lock-LDB
15	-	Belt transmission
16	-	Mechanical stops



**NOTE:** the given operating and performance features can only be guaranteed with the use of DITEC accessories and safety devices.

# 5. Installing the automation

## 5.1 Installing / Removing the cover

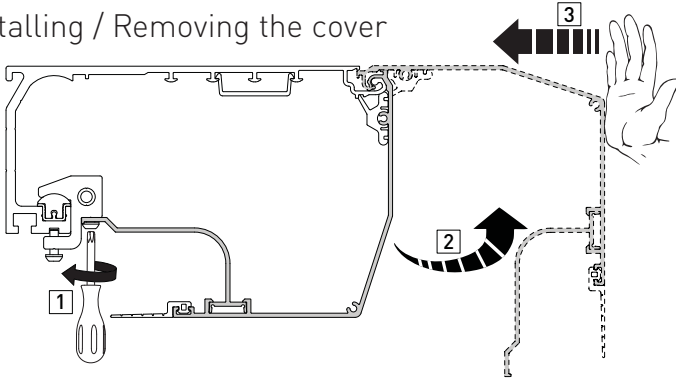

- Secure and unsecure the open cover as shown below.

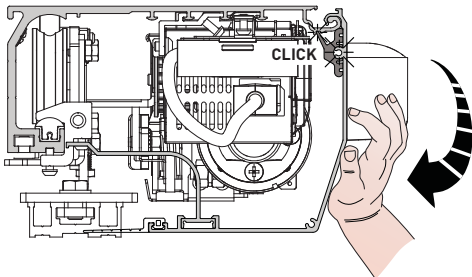
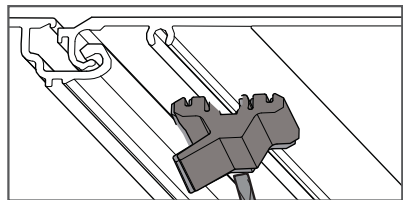
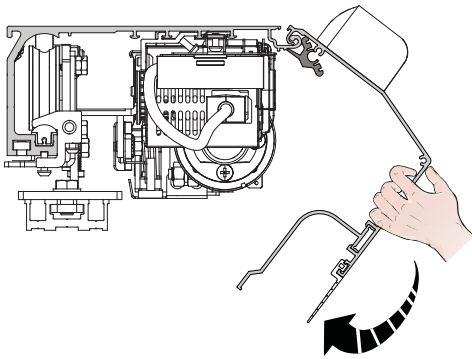
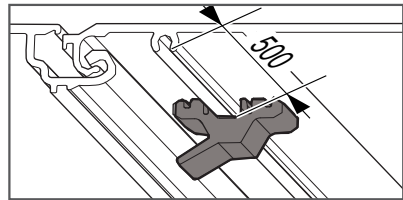
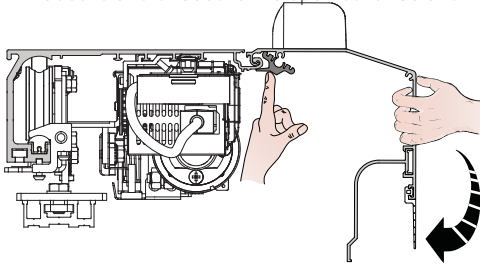



## 5.2 Installation/removal of the cover if installed side presence sensor

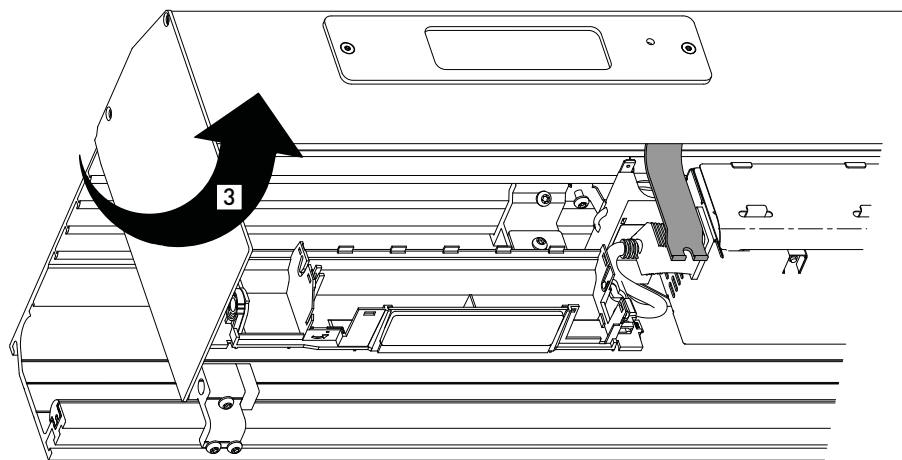
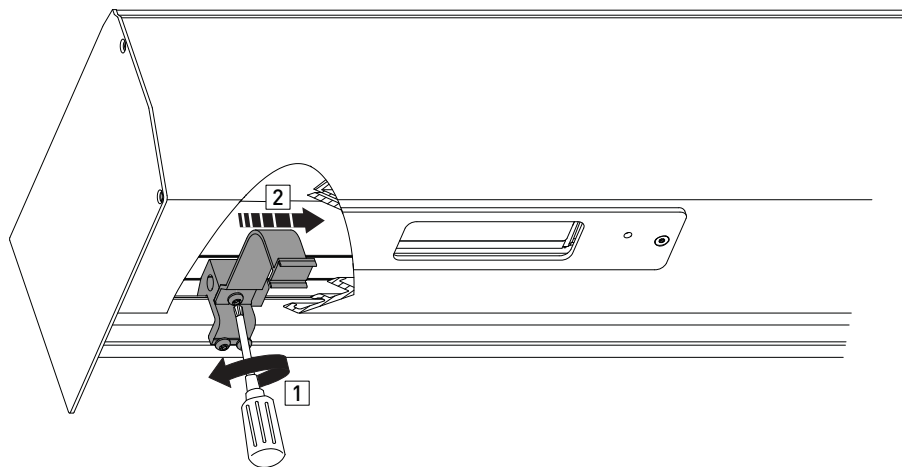

## 6. Examples of installation

### 6.1 Example using supplied wing anchoring brackets

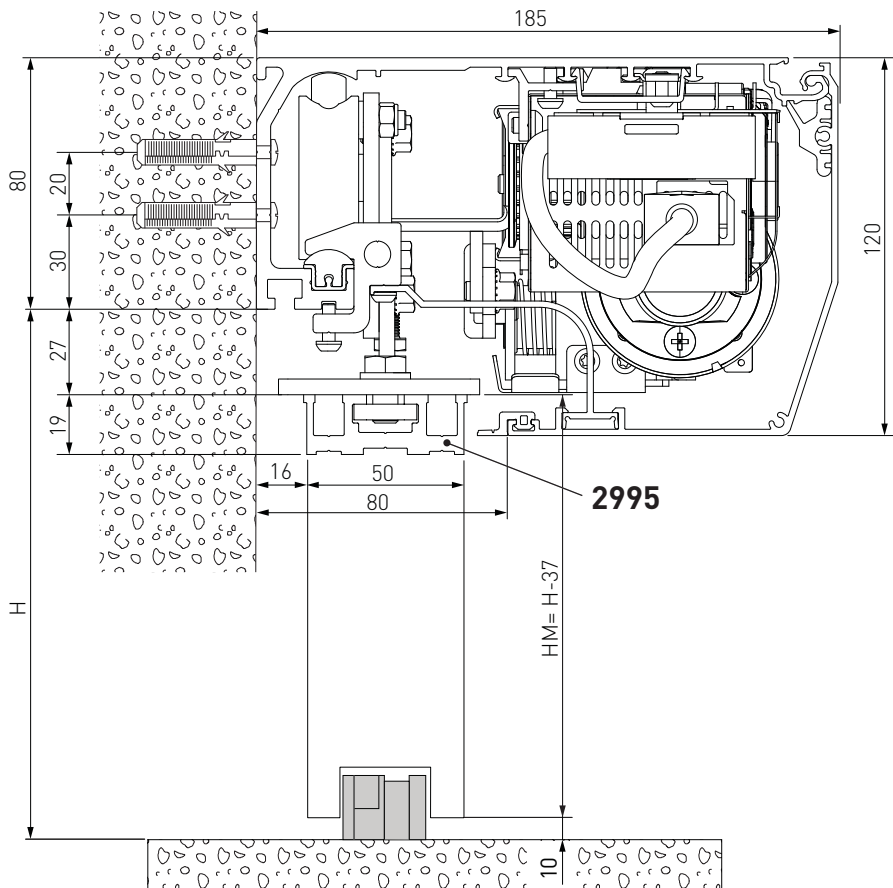

Unless otherwise specified, all measurements are expressed in millimetres (mm).

The figure shows the measurements for fastening the automation to the wall, considering that the automation door wings are made using profiles not manufactured by us.

If the door wings are made with DITEC profiles in the ALU/PAM series: refer to the measurements given in the relative manuals. Drill a hole in the box using the reference line on the back and fasten it with M6 Ø12 steel plugs or 6MA screws (not supplied).

Distribute the fixing points approx. every 400 mm. Make sure the box is positioned evenly, with its back surface perpendicular to the floor and not deformed lengthwise by the shape of the wall. If the wall is not straight and smooth, iron plates must be fixed to it and then the box in turn fixed to the plates.



**WARNING:** the fastening of the box to the wall must be sufficient to sustain the door wing weight.



**WARNING:** do not damage the wheel guide during assembly. Clean the guide thoroughly before installing the wings.

## 6.2 Examples with DAS11M8

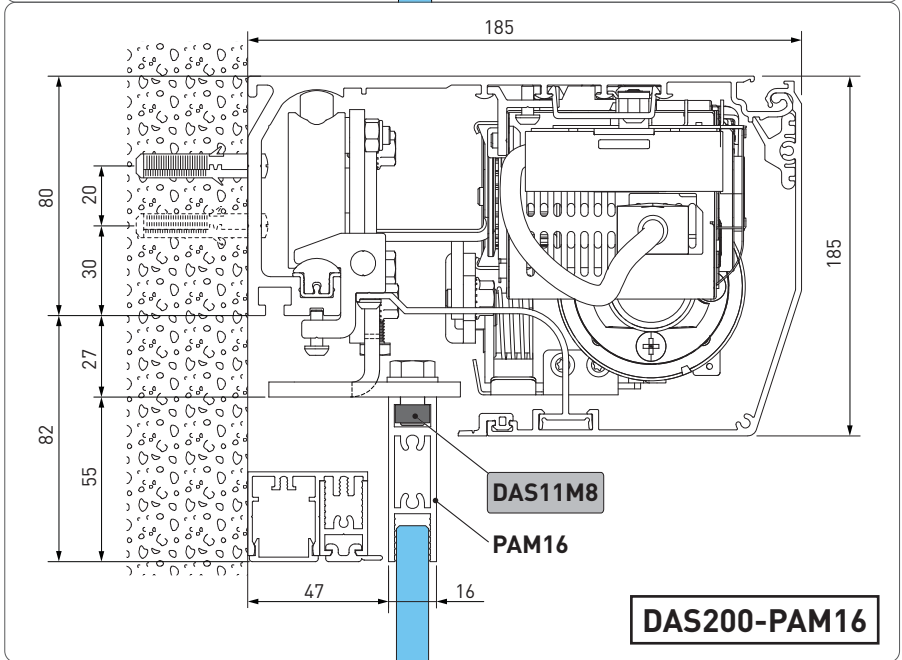
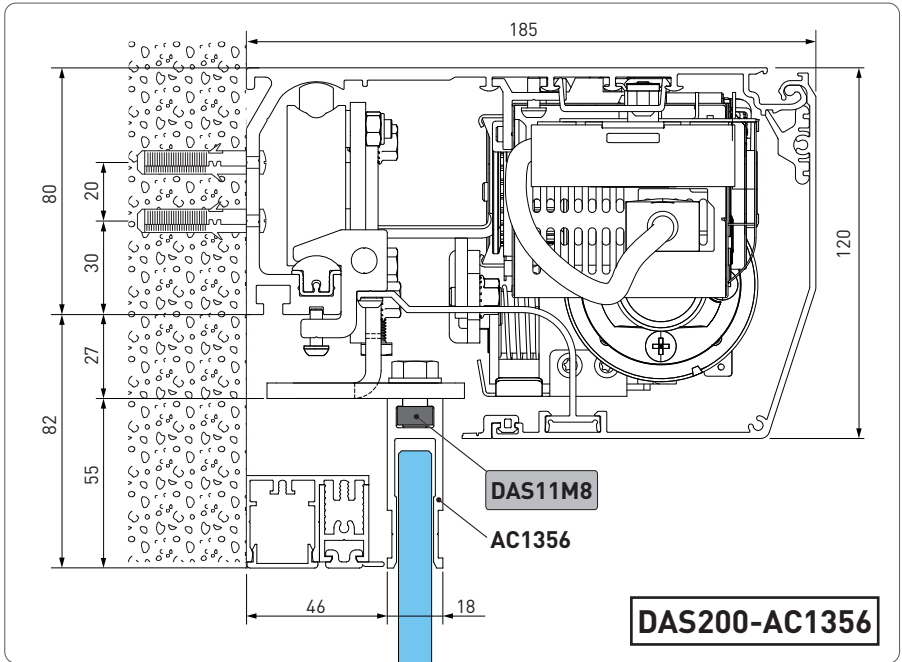

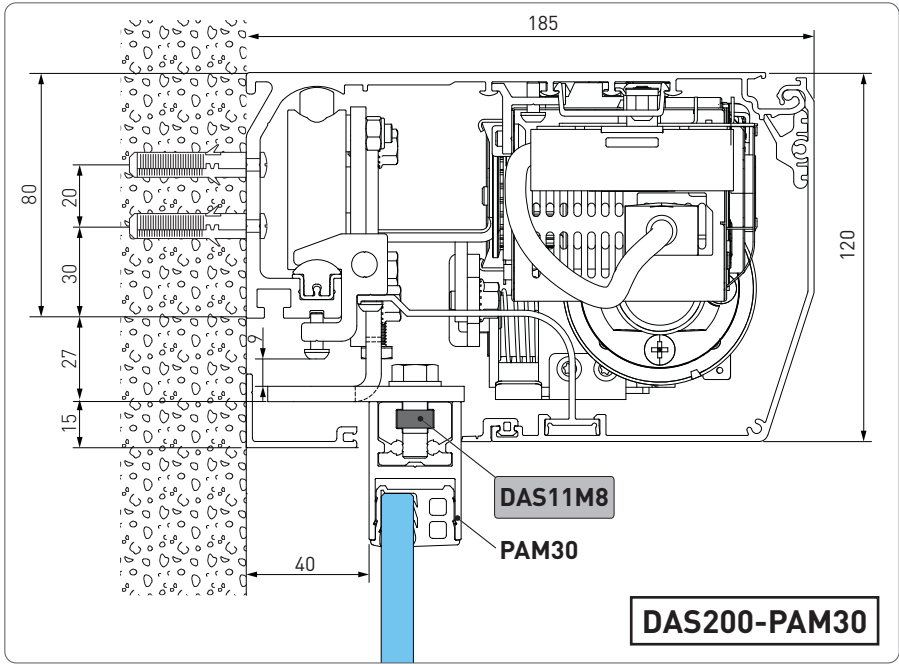

### 6.3 Examples with DAS18M8

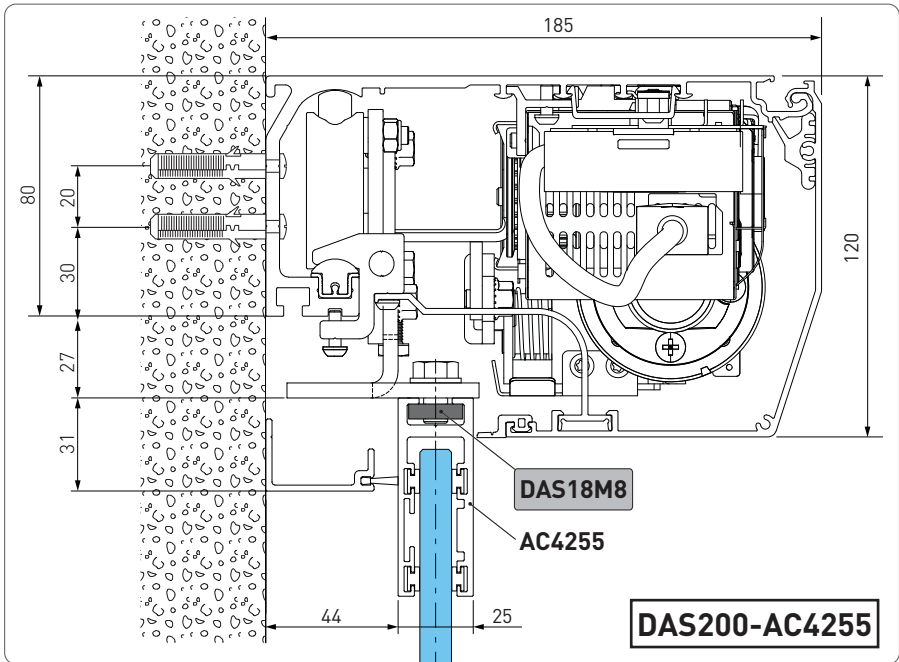

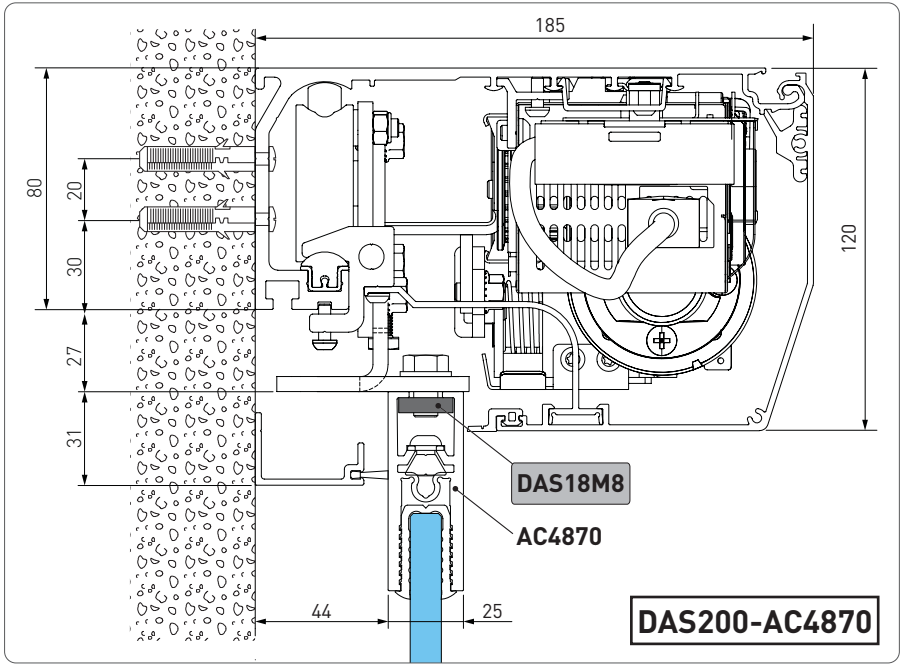

#### 6.4 Example with DAS35M8

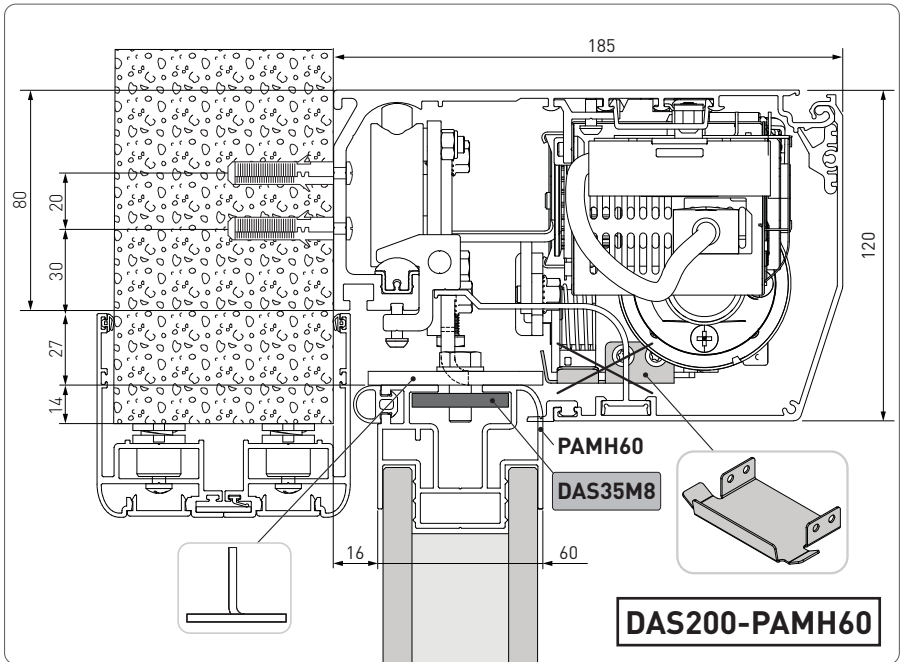

## 6.5 Example with DAS40M8

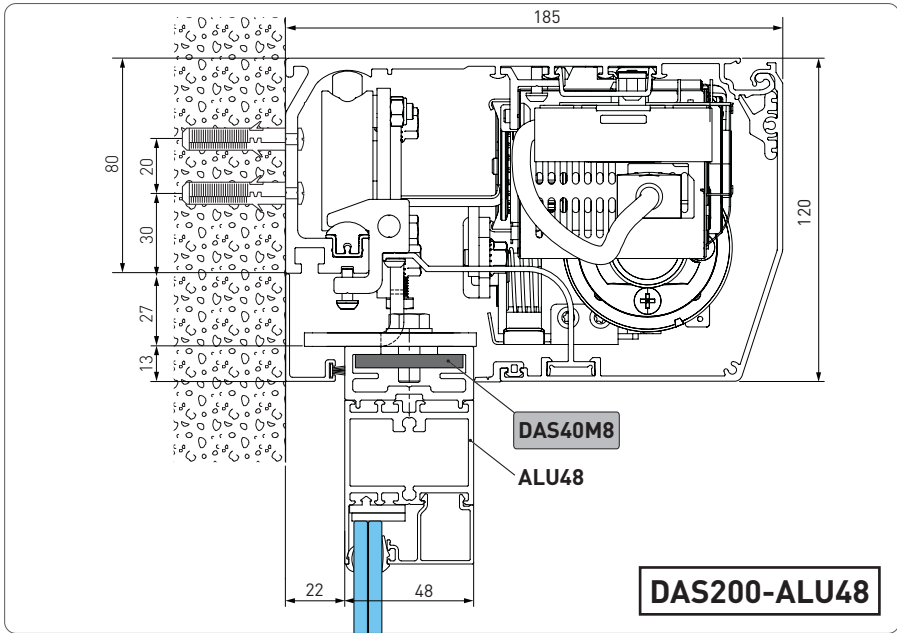

## 6.6 Example with ACV

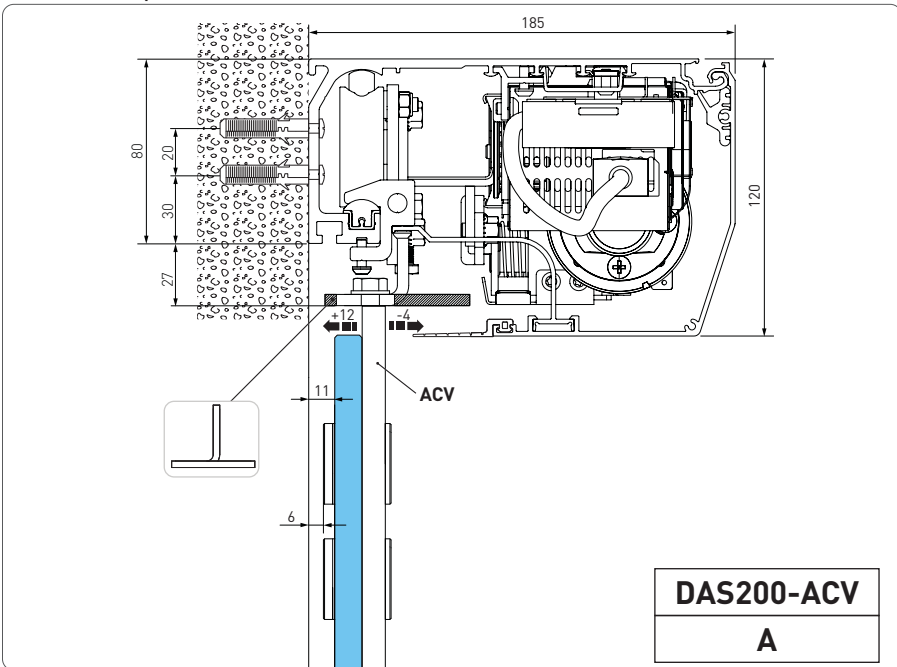

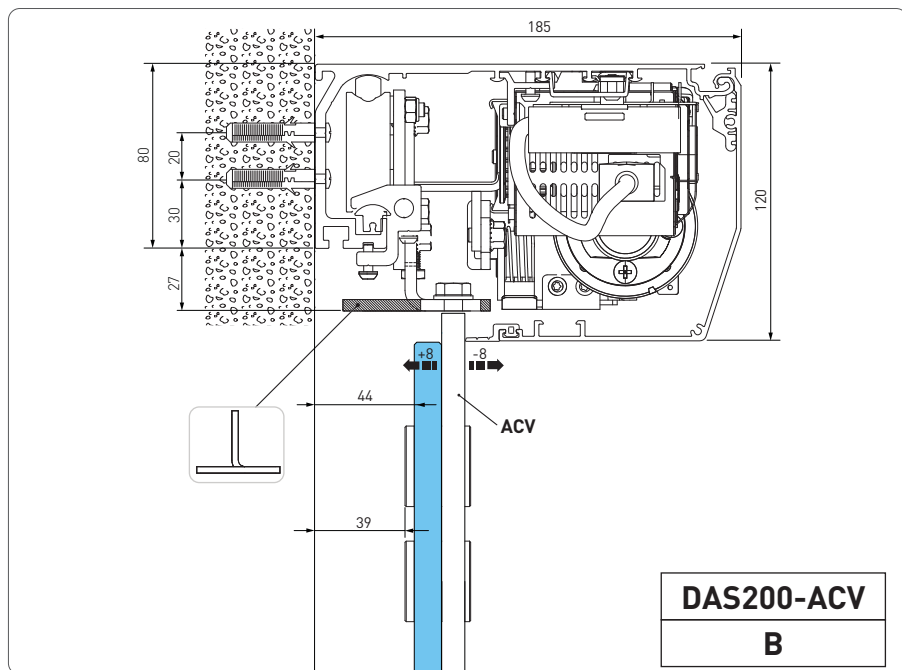

## 7 Preparation of the glass door wing

The diagram indicates the process measurements of the aluminium profile AC1356 and glass. Ø10 through holes are required on the aluminium profile and Ø15 on the glass for fastening. The number of holes and related distance between centres are based on the door wing width. Silicon should ideally be used between the edge of the glass and the internal base of the profile.

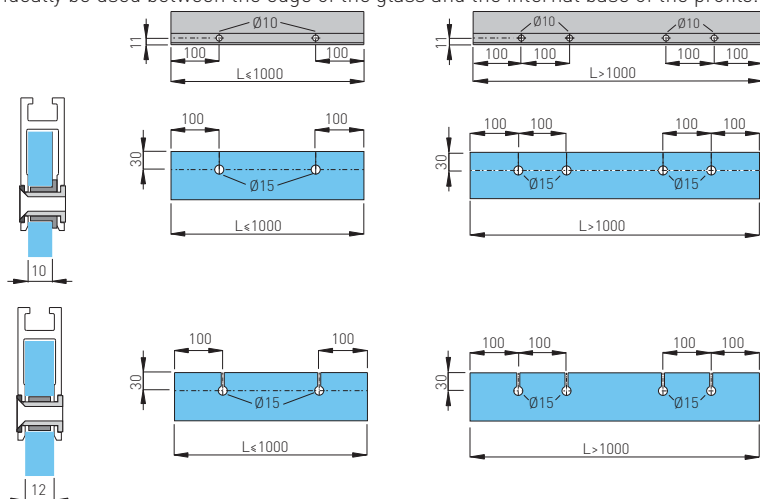

With AC4255 or AC4870 glass wing attachment applications, see the respective manual.

## 7.1 Installing and adjusting the door wings

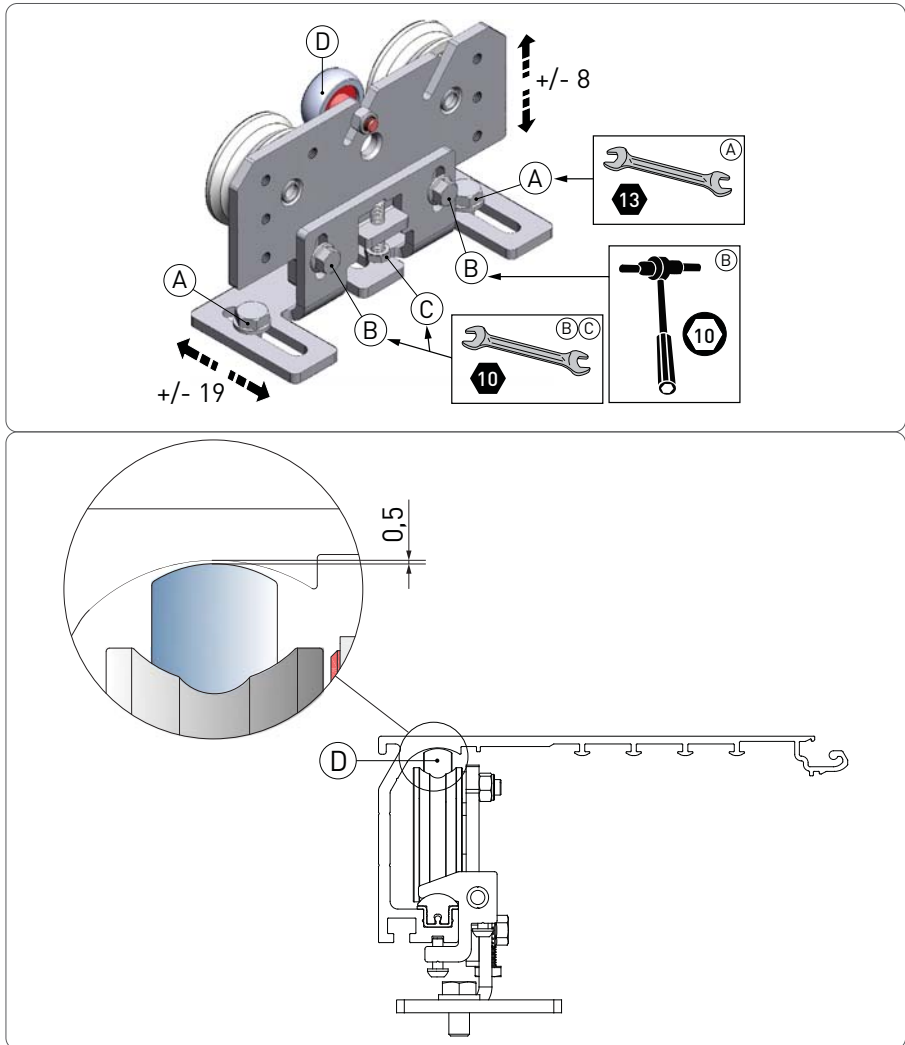

Make sure that the central wheel [D] is adjusted as illustrated in the picture.

Fix the door wing to the carriage with screws [A].

The door wing can be adjusted as shown in the figure.

- Loosen the screws [B] and adjust the height by turning the screws [C];
- Adjust the side position of the door wing by turning the screws [A];
- Move the door wings manually and make sure they move smoothly and freely and that all the wheels rest on the guide.



**WARNING:** for all-glass door wings without seals, leave a gap of at least 10 mm in the closed position to avoid contact between the glass sheets.



## Automation with two door wings

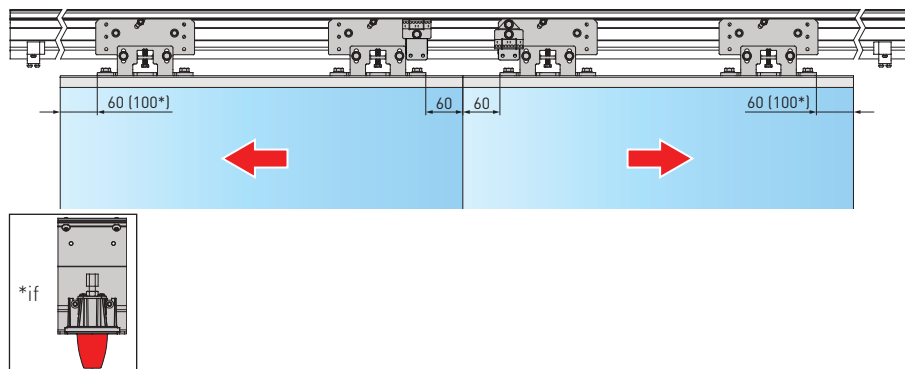

## Automation with one door wing with right-hand opening

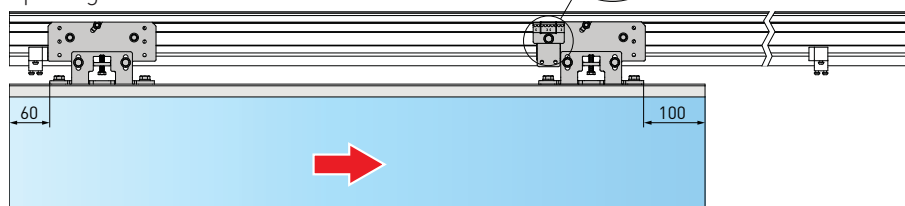

## Automation with one door wing with left-hand opening

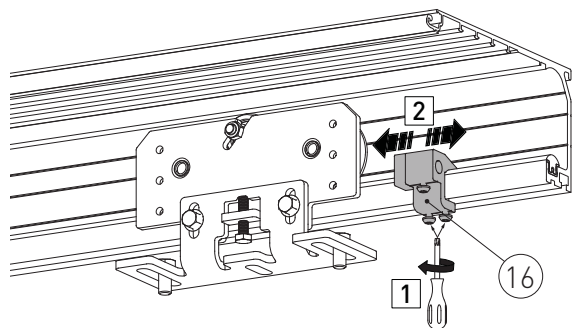
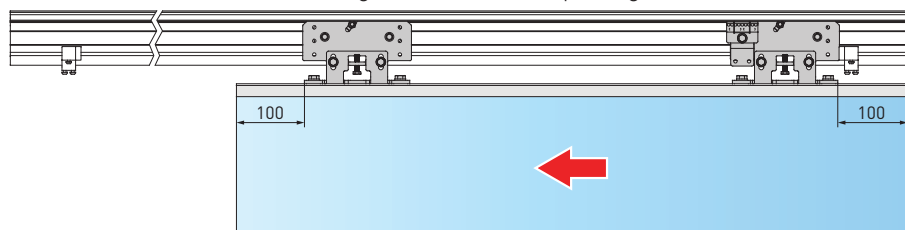

Place the end stops (16) on the opening and closing positions.

For the 2 wing automations, a third end stop is provided which must be placed near the end of the box which is used as a stop for the cover support.

## 7.2 Installing the floor guides

The floor guides must be made of an anti-friction material such as PVC, NYLON or TEFLON. The length of the floor guide should be no greater than the overlap between the fixed and mobile door wings, and should not enter the passage opening.

Examples of floor guides

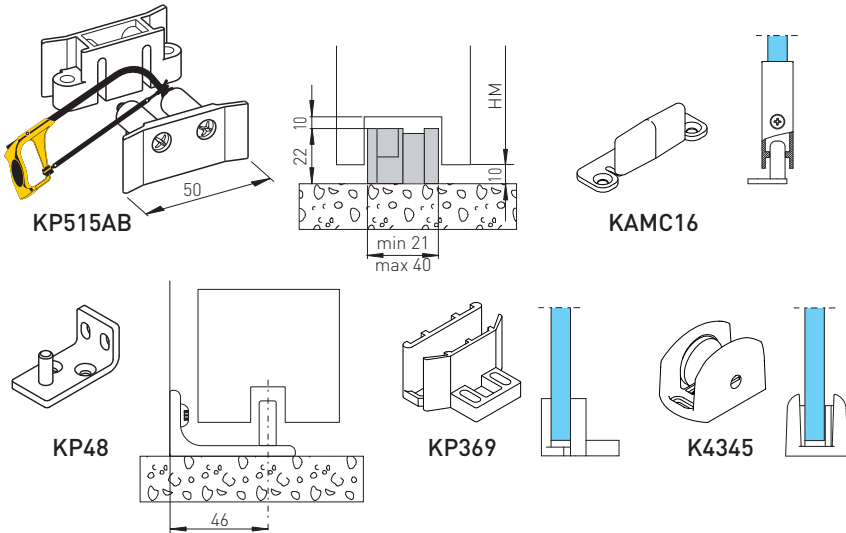

## 7.3 Belt stop installation

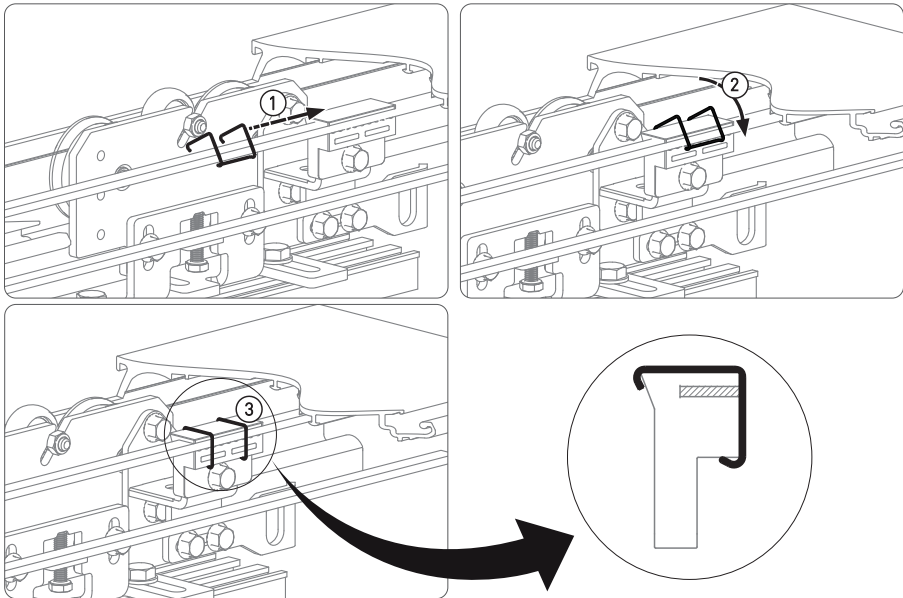

## 7.4 Checking and adjusting the belt tension

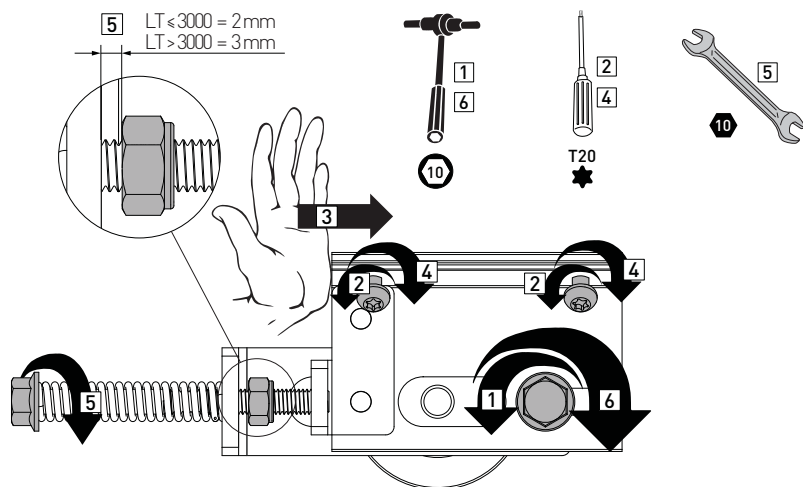

## 7.5 Sensor positioning on the cover

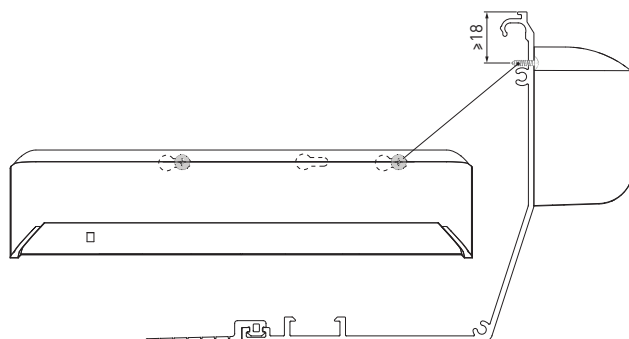

## 7.6 External sensor cable fixing (2 wings operator)

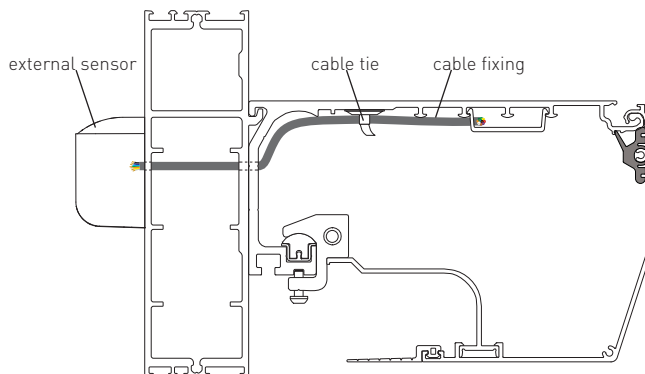

## 8. Electrical connections



Connect the automation to an efficient earthing system that complies with current safety standards.

During installation, maintenance and repair operations, cut off the power supply before opening the cover to access the electrical parts.

The automation protection casing must be removed by qualified personnel only.

An omnipolar disconnection switch with a contact opening distance of at least 3 mm must be fitted on the mains supply.

Check there is an adequate residual current circuit breaker and overcurrent cutout upstream of the electrical system.

Install an electric switch next to the automatic system.

Make sure there are no sharp edges that may damage the power supply cable.

If the power cable is damaged, have it replaced by the manufacturer or qualified personnel.



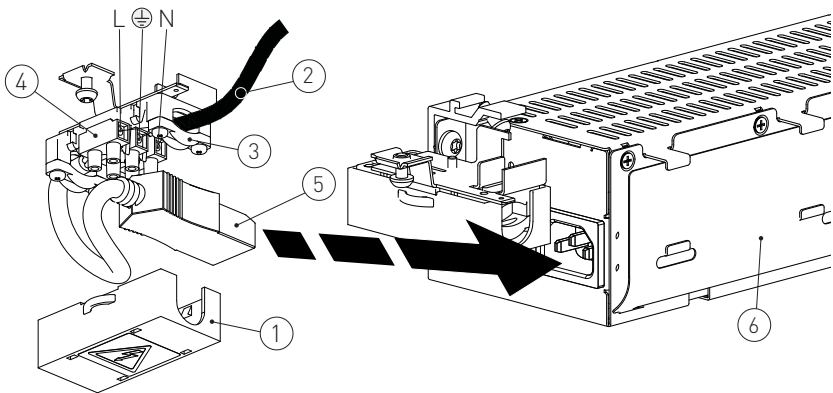

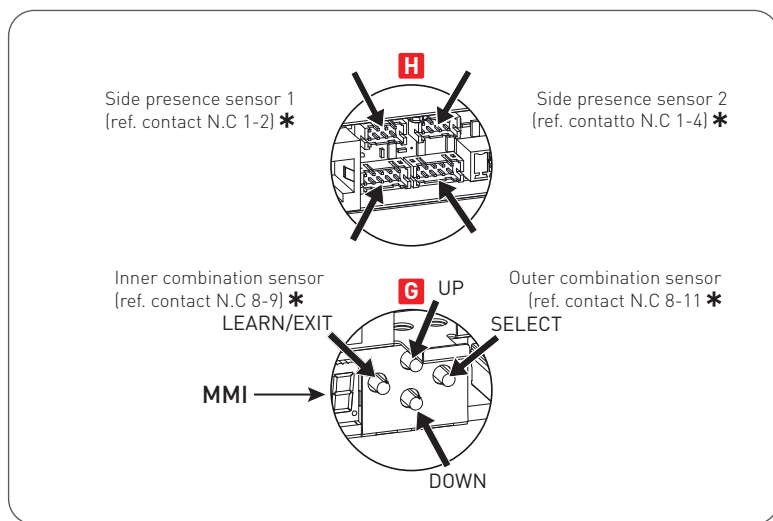
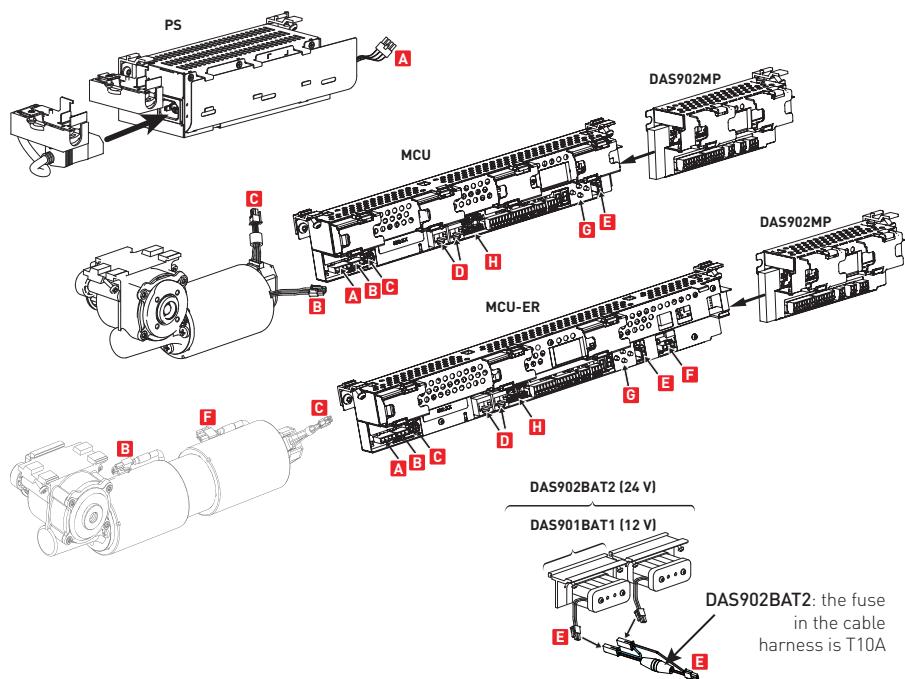

- Use a H05RN-F 3G1,5 or H05RR-F 3G1,5 type electric cable.
- Remove the protective cover [1].
- Connect the power cable [2] to the terminal board [4], locking it in place with the cable fastener [3].
- Replace the protective cover [1].
- Connect the connection cable [5] to the power supply unit [6].



## 8.1 Standard electrical connections

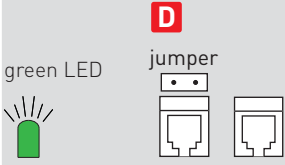
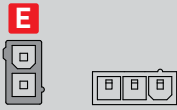

\* if these connections are used, do not jumper the corresponding N.C contacts on the control panel.

Output	Description
	<b>Power supply unit connection</b>
	<b>Motor connection</b>
	<b>Encoder connection</b>
	<b>Connection for:</b> - Program selector (OMS); - Network connection of interconnected operators; - Connector for Bluetooth interface; <b>Green LED:</b> If this LED is switched off or flashing, it means the control panel is malfunctioning. <b>JUMPER:</b> For interconnecting more than two units (control unit and/or operation mode selectors).
	<b>DAS901BAT1 - DAS902BAT2 battery kit connection (optional)</b> In the event of a power failure the operator will carry out an opening operation (factory setting). See parameters 10, 36, 38, 41 and 43 for selection of operation and monitoring.  <b>NOTE:</b> Monitoring will be made if parameter 10 is set to Convenience Monitoring (01).  <b>WARNING:</b> for charging purposes, the battery kit must be connected to the control panel at all times. Periodically check the efficiency of the battery kit. When there is no voltage, the door can only be opened with a KEY com-mand connected between 8-12.  <b>NOTE:</b> use battery type 12V, 1,2Ah NiMH. If a different type of battery is used it can damage! <b>NOTE:</b> DAS902BAT2: the fuse in the cable harness is T10A.
	<b>DAS200RG/KS200RG motor connection</b>

## 8.2 Control panel commands





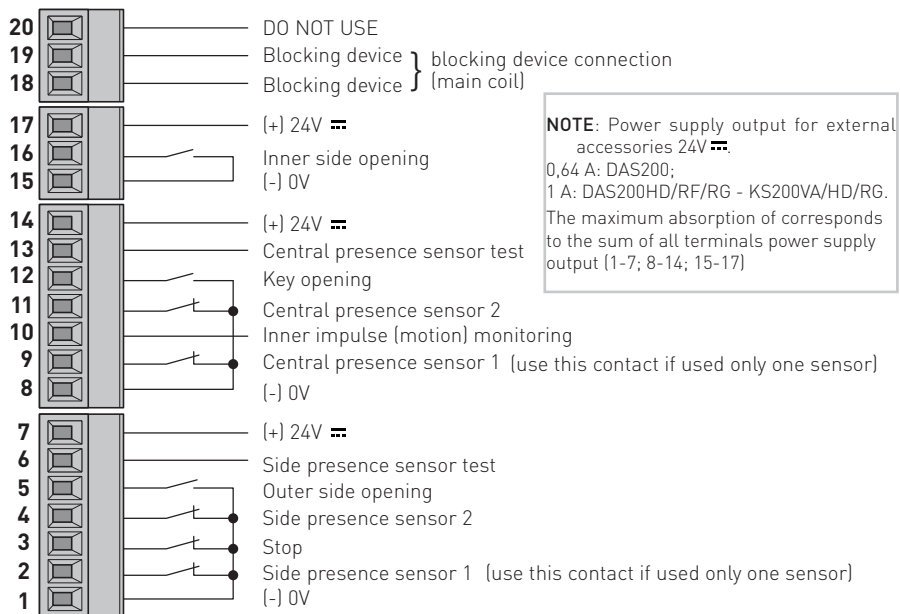







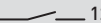

### Jumper the unused N.C. contacts

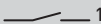

### 8.2.1 Commands

Contact			Description
1 — 2 (ref. parameter 27)	N.C.	SIDE PRESENCE SENSOR 1	Connect side presence sensor 1 as shown in the example in paragraph 12.
1 — 3 (ref. parameter 46)	N.C.	STOP	The opening of the safety contact causes the current operation to stop. <b>WARNING:</b> when the contact closes again, the door closes. <b>WARNING:</b> The emergency opening (battery 12V), is priority (=door opens in case of mains power failure even if STOP contact is open).
1 — 4 (ref. parameter 28)	N.C.	SIDE PRESENCE SENSOR 2	Connect side presence sensor 2 as shown in the example in paragraph 12.
1 — 5	N.O.	OUTER SIDE OPENING	Connect the external sensor as shown in the example in paragraph 12. The closure of the contact activates the door opening operation.
6 (ref. parameter 29)		SIDE PRESENCE SENSOR TEST	Connect the test clamp of the side sensors. Clamp 6 activates a test on the side safety sensors before every operation. If the test fails, an alarm message appears on the display. The door will open and remain open until the fault is cleared
1 — - 7 — +		POWER SUPPLY TO ACCESSORIES	24 V $\equiv$ accessories power supply.

Contact		Description
8  9 (ref. parameter 07)	N.C.	CENTRAL PRESENCE SENSOR 1 Connect central presence sensor 1 as shown in the example in paragraphs 12.
10  (ref. parameter 16)		INNER IMPULSE (MOTION) MONITORING Connect the test clamp of the escape route central sensor. If the test fails, an alarm message appears on the display. The door will open and remain open until the fault is cleared.
8  11 (ref. parameter 08)	N.C.	CENTRAL PRESENCE SENSOR 2 Connect central presence sensor 2 as shown in the example in paragraph 12.
8  12 (ref. parameter 04)	N.O.	KEY OPENING Closing the contact via a key command activates an opening operation and a closing operation after the time selected by parameter 04. If used for opening in DOOR CLOSED mode: <ul style="list-style-type: none"> <li>•In the presence of a mains power supply or continuity batteries, a 8-12 command partially opens the door and closes it after the time selected by parameter 04.</li> <li>•If there is no mains power supply, a 8-12 command reactivates the batteries, if present, for the time required to perform a complete opening operation and then the batteries are disconnected from the control panel.</li> </ul>
13  (ref. parameter 09)		CENTRAL PRESENCE SENSOR TEST Connect the test clamp of the presence sensors. Command 13 activates a test on the central safety sensors before every operation. If the test fails, an alarm message appears on the display. The door will open and remain open until the fault is cleared.
8  - 14  +		POWER SUPPLY TO ACCESSORIES 24V  accessories power supply.
15  16	N.O.	INNER SIDE OPENING Connect the internal sensor as shown in the example in paragraph 12. The closure of the contact activates the door opening operation.
15  - 17  +		POWER SUPPLY TO ACCESSORIES 24V  accessories power supply.
18   19 (ref. parameter 05)		BLOCKING DEVICE CONNECTION (main coil) Output for connecting an electro-mechanical block (optional). The blocking device is automatically selected during the learning phase (except bistable lock).



### 8.3 DAS902MP plus module (optional)

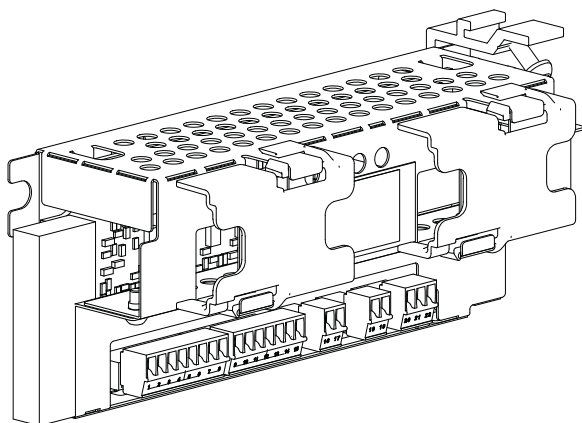



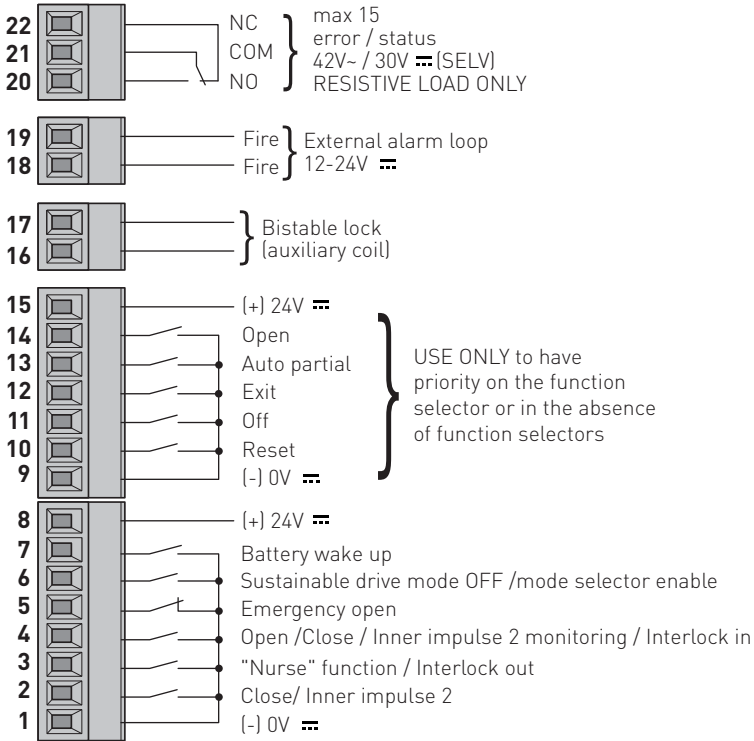

For extra functionality like:

- close impulse;
- nurse impulse;
- open/close impulse;
- emergency open impulse (fireman's opening);
- bi-stable lock;
- connection of optional operation mode selector;
- fire impulse;
- sustainable function off;
- relay out put for external error status indication, maximum 15W, 42VAC/ 30VDC (SELV), resistive load only;
- second monitored inner impulse;
- mode selector COM500ER enable impulse.







## 8.4 DAS902MP commands



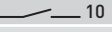

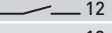

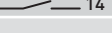
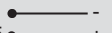
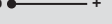



Contact			Description
1 — 2 (ref. parameter 93)	N.O.	a) CLOSE b) INNER IMPULSE 2	a) Close impulse. b) When two inner impulses are to be used. Sets input to inner impulse 2.
1 — 3 (ref. parameter 90)	N.O.	a)"NURSE" FUNCTION b) INTERLOCK OUT	a)The door will open to partial opening in operation mode selections EXIT, AUTO and PARTIAL. b) When configuring for interlock also set parameter 6A = 01.
1 — 4 (ref. parameter 91-92)	N.O.	a) OPEN/CLOSE b) INNER IMPULSE 2 MONITORING c) INTERLOCK IN	a) One impulse opens the door the next impulse closes the door. Available in mode EXIT, AUTO, PARTIAL. b) Inner impulse 2 monitoring for the second inner impulse. Set also parameter 93=03. c) When configuring for interlock also set parameter 6A = 01.
1 — 5 (ref. parameter 96)	N.C.	EMERGENCY OPEN	Used to give opening (fireman's opening) impulse to the door in any operation mode selector setting. With electrical emergency unit also during power failure.
1 — 6 (ref. parameter 99)		a) SUSTAINABLE DRIVE MODE OFF b) MODE SELECTOR ENABLE	a) Disables Sustainable drive mode. b) Enable the Mode Selector with a key (only COM500ER).

1  7	N.O.	BATTERY WAKE-UP IF NO MAIN POWER	The impulse opens the door fully and stop there.
1  - 8  +		POWER SUPPLY TO ACCESSORIES	24V  accessories power supply.

## Connection of additional functions (ref. parameter 97)

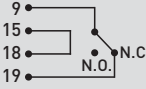
Contact			Description
9  10	N.O.	RESET	It deletes all the data learned by the control panel.
9  11	N.O.	OFF	The door closes and remains closed and locked (if lock is present).
9  12	N.O.	EXIT	For one-way operation from the inside of the door.
9  13	N.O.	AUTOPARTIAL	For two-way partial opening.
9  14	N.O.	OPEN	The door opens and remains open.
9  - 15  +		POWER SUPPLY TO ACCESSORIES	24V  accessories power supply.

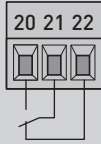
Contact		Description
16  17 (ref. parameter 98)	BISTABLE LOCK (AUXILIARY COIL)	Power supply for bistable lock (auxiliary coil)
18  - 19  + (ref. parameter 36)	FIRE ALARM CIRCUIT CONNECTION	<p>Fire closing/opening. Example of connection:</p> <p>18  - 12-24V  external alarm loop 19  -</p> <p>or</p> 

Contact		Description
	ERROR / STATUS	<p>A door / alarm status signaling device can be connected. max 15W 42V ~ / 30V  (SELV) only resistive loads</p> <p> <b>NOTE:</b> for relay configuration use DAS900CT.</p>

## 9. Adjustment and selection of control functions

The control panel has a two-figure display that displays text and/or numbers.  
It has four buttons. (MMI)

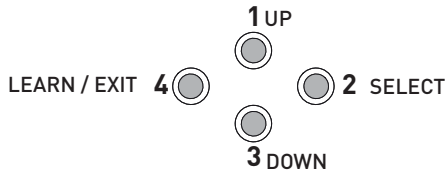



The procedure to switch on the display is as follows:



press the 2-SELECT key to launch the display test



**NB:** make sure all seven segments of the two displays light up correctly to avoid incorrect reading.

- **1 UP:** to increase the parameter number or value in it;
- **2 SELECT:** to enter a parameter or value to be programmed in the memory;
- **3 DOWN:** to decrease the parameter number or value in it;
- **4 LEARN/EXIT:**
  - **LEARN** has 3 functions: 1, 2, 3.
    1. Quick learning. If pressed for longer than 1 second but less than 2, the electronic accessories connected to the control board are recognised.
    2. Normal learning. If pressed for longer than 2 seconds, the display flashes . Two seconds after releasing the button, a complete learning cycle begins which performs an opening and closing operation to carry out the operations described in chapter 8.
    3. Restore factory settings. If pressed for longer than 10 seconds, the control panel restores the factory settings .
  - **EXIT** quits the parameter menu or value without saving the changes. If **EXIT** is not pressed, the control panel returns to the default display  after 3 minutes of inactivity.



**N.B.:** the set value is stored by the control panel by pressing **SELECT** irrespective of whether the value has been modified or not. Press **EXIT** if you do not want to store the value.

When a value is programmed, that parameter is excluded from the learning cycle. Even if a new learning cycle is executed, that value will not be modified.

To include the parameters in the learning cycle again, the factory settings must be set.

## 9.1 Display test

- When the display shows "0n", push the SELECT button and each of the two display windows make a rotating test pattern.
- Verify that all seven segments of the two display windows are lit during the test. If not there is a risk of misjudgment of the digits shown in a defective display.
- When the display test is finalized the display shows two steady digits indicating the first parameter.

Display	Char acter	Display	Char acter	Display	Char acter	Display	Char acter	Display	Char acter
	0		5		A		e		S
	1		6		b		F		t
	2		7		C		n		
	3		8		d		o		
	4		9		E		P		

## 9.2 Status indication on the display

The display shows the different impulses that are active. The status viewing starts with showing "5t" as for Status, then one or many numbers representing the different active impulses in to the operator.

The different impulses are:

- 00= Key Impulse
- 01= Inner impulse
- 02= Outer impulse
- 03= Synchronisation
- 04= Interlock in impulse
- 05= Presence impulse 1
- 06= Presence impulse 2
- 07= Side Presence impulse 1
- 08= Side Presence impulse 2
- 09= Stop impulse
- 10= Emergency open impulse
- 13= Close command
- 14= Nurse impulse
- 24= Push and Go impulse
- 25= Open-Close impulse
- 28= Fire impulse
- 47= Interlock Disable (not used)

## 10. Start up



**NOTE:** for DAS200RF follow the start up procedure indicated in the DAS200RFKA kit manual.



Before performing any type of operation, make sure that the automation is turned off and the batteries are disconnected.

Start-up and adjustment must be performed in the following order when the automation is installed:

1. Connect the accessories, opening and safety sensors, blocking device, batteries and selector.
2. Jumper the safety contacts **1-2**, **1-3**, **1-4**, **8-9**, **8-11** on the control panel and **1-5** on plus module DAS902MP, if not used.
3. Connect the mains power supply to the automation.
4. **Set the following parameters:**

Parameter	Description	Settings
<b>05</b>	Lock configuration (main control)	<b>KS200VA/HD/RG.</b> The lock is not automatically learned, set manually the lock type: <b>00</b> = no lock. <b>01</b> = antipanic belt lock (KS802BLOKA-LDP) and bistable belt lock (KS802BLOKB-LDB). <b>02</b> = standard belt lock (KS802BLOK-LD). <b>DAS200/HD/RF/RG.</b> The bistable lock DAS802LOKB is not automatically learned, set the lock type 12 *: <b>10</b> = no lock, automatic setting. <b>11</b> = antipanic belt lock (DAS802LOKA-LDP), automatic setting. <b>12</b> = standard lock (DAS802LOK-LD), automatic setting and bistable lock (DAS802LOKB-LDB), manual setting.
<b>06</b>	Lock release	<b>00</b> = Off. <b>01</b> = On. On DAS200RF set <b>01*</b> . If lock type is set manually (parameter 5), set <b>01*</b> .
<b>09</b>	Central presence sensor test	<b>00</b> = None (factory setting). <b>01</b> = Presence sensor 1 (set if a presence sensor with monitoring is installed). <b>02</b> = Presence sensor 1 and 2 (set if two presence sensors with monitoring are installed).
<b>12</b>	Selection of opening direction	<b>00</b> = right hand opening for single door wing automation. <b>01</b> = left hand opening for single door wing automation and for double door automation (factory setting). <b>NOTE:</b> on DAS200RG and KS200VA/HD/RG this parameter cannot be set, the opening direction is defined with the position of the belt attachment bracket.
<b>16</b>	Inner Impulse (motion) Monitoring	According to EN16005 or DIN18650 it is a demand to have Inner impulse monitoring= On in escape routes. <b>00</b> = Disables monitoring. <b>01</b> = Enables monitoring. <b>NOTE:</b> On DAS200RF set to <b>01 *</b> <b>NOTE:</b> On DAS200RG and KS200RG this parameter is set to <b>01 *</b> .
<b>29</b>	Side presence sensor test	<b>00</b> = None (factory setting) <b>01</b> = Presence sensor 1 (set if a presence sensor with monitoring is installed). <b>02</b> = Presence sensor 1 and 2 (set if two presence sensors with monitoring are installed).
<b>67</b>	Selection of the type of automation	<b>00</b> = Automation with one door wing *. <b>01</b> = Automation with two door wings *.
<b>98</b>	Lock Configuration, terminal 16-17 DAS902MP	<b>NOTE:</b> Set ONLY if installed bistable lock DAS802LOKB. <b>11</b> = Bistable lock.

99	Function Select, terminal 6 DAS902MP	00= No function. 01= Disables Sustainable drive mode. 02= Enable the Mode Selector with a key (only COM500ER).
B1	Operation mode selector key lock (for COM500ES, COM501ES/ER, COM502ES/ER)	00= No access code (do not use for escape route). 01= Hold for two sec.possible use with COM500ES, COM501ES, COM502ES (do not use for escape route). 02= Passcode, possible use with COM500ES (do not use for escape route), COM501ES, COM502ES. 03= Key (to use with COM501ER/COM502ER).

\* If the Configuration Tool CT is used, disable the "learn access":

MMI Write access
 MMI Read access
 Learn Access



**i** **NOTE:** Parameter 10 (Emergency Unit Monitoring) on DAS00RG and KS200RG is set up on 02= redundant monitoring.

**i** **NOTE:** If the 12V battery is used set parameter 43=05.

- \*Leave ajar the casing and, if there are safety sensors, check that they are in standby mode and that there are no people or objects moving in the sensors detection area.

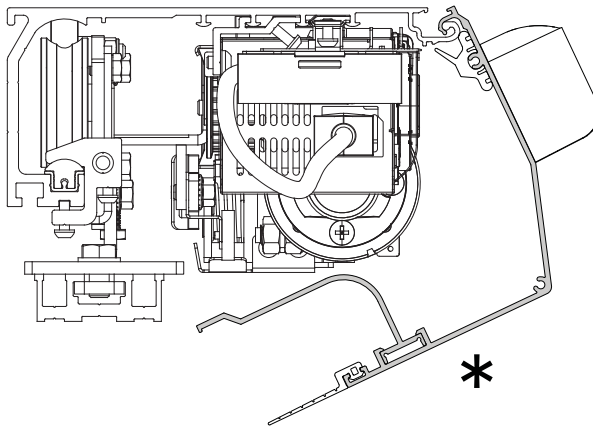

- Press the LEARN button for 2 seconds, the display flashes L.



To enable the stroke and weight of the door wings to be acquired correctly, the acquisition phase must be performed with the door wings installed.

- Free the area of action of the sensors so that they are detected and monitored during the learning cycle.
- The automation performs opening and closing operations.

During this cycle, the following accessories connected to the control panel are recognised and some parameters detected:

Accessory / Parameter	Parameter number
High Speed Closing	02
Presence of block and type, except bistable lock / KS200VA/HD/RG	05, 06
Whether the sensors are monitored or not	9, 16, 29, 31, 91
Presence of battery and type	41
Power supply type	64
Door type	67
Measurement of width of passage opening	-
Calculation of weight of door wing(s) - (except DAS200RF)	68
Calculation of friction in the system	69

At the end of the learning cycle, the door remains closed and the display indicates .

If some parameters have not been automatically configured during the learning cycle, the door opens. The display first indicates , and then the parameter that has not been acquired automatically, for example, if the door is a 2-wing or 1-wing door (parameter 67).

These parameters must be configured by the installer and/or check that there are no obstacles and friction which prevents correct learning.

1. Press the **SELECT** button to start to modify the parameters.
2. Press **SELECT** again to display the parameter value in flashing mode.
3. Select the correct value using the **UP** and **DOWN** buttons.
4. Press **SELECT** to confirm and program the selected value.
5. Continue to configure the other parameters that have not been acquired.
6. Press **LEARN/EXIT** for more than 2 seconds and the display will indicate  after 2 seconds, the door closes and is ready for operating.

If necessary, you can adjust the following main parameters:

Parameter	Description	Settings
00	High Speed Opening (cm/s)	10÷80cm/s
02	High Speed Closing (cm/s)	10÷80cm/s
03	Hold Open Time (00÷60s)	(00÷60s)
11	Partial opening (00-99%)	(00-99%)
15	Run Program (01÷05)	Performance adjustment. Sets how fast or slow the door shall accelerate or break. 01= Smooth, for light doors. 05= Max Performance. For heavy doors.
38	Convenience battery 24V, DAS902BAT2 (00÷01)	00= Off 01= On <b>NOTE:</b> on DAS200RG /KS200RG this display is not visible and is set to 00.
 49	Opening Max Force (02÷23N x 10)	If the reopening maneuver occurs too abruptly, set parameter 49 with a value lower than the factory value (10), example 04 - 05.

- For other parameter variations, see the "Parameters" chapter.
- Make sure the installation complies with the current regulations and the essential requisites laid down by the relevant authorities.
- At the end of the start-up close the cover and fix it with the appropriate screws, see chapter 5.1.



# 11. Parameters

## 11.1 Configuration parameters according to function

For more information on the parameters, see paragraph 9.2.

SPEED parameters		
Parameter	Description	Range
00	High speed opening	10÷80cm/s
01	Low speed	05÷80cm/s
02	High speed closing	10÷80 cm/s

TIME parameters		
Parameter	Description	Range
03	Hold open time	00÷60s
04	Key hold open time	00÷60s
20	Partial hold open time	00÷60s
21	Push & Go hold open time	00÷60s
22	Auto width activation time	00÷60s
23	Auto width resume time	00÷60s
24	Jam hold time	00÷10s
25	Interlock disable time	00÷60s
26	Presence hold open time	00÷60s
92 [DAS902MP]	Open/Close timeout ref. terminal 4	00÷03

FUNCTION parameters		
Parameter	Description	Range
5E	Status indication. Off (00) / On (01)	00÷01
5F	Default programming. Off (00) / On (01)	00÷01
12	Opening direction. 1 wing Right (00) / 1 wing Left or 2 wings (01). On DAS200RG and KS200VA/HD/RG not selectable	00÷01
13	Hold force	00÷60N
2A	Side presence function. Safe speed (00) / Stop door (01)	00÷01
32	Active brake on stop. Off (00) / On (01)	00÷01
33	Push & Go in EXIT mode selection. Off (00) / On (01)	00÷01
34	Hold force in EXIT and OFF mode selection. Off (00) / On (01)	00÷01
35	Toggle operation mode selector after stop. Off (00) / On (01)	00÷01
53	Operator type. Slider (00) / mechanical emergency unit DAS200RF (04)	00÷04
54	Service Needed Operating Hours	00÷60h x 1000
55	Service needed opening cycles	00÷50 x 100.000
60	Learn. Off (00) / On (01)	00÷01
61	Auto width. Off (00) / On (01)	00÷01
65	Sustainable Drive Mode. Off(00) / On(01)	00÷01
6A	Interlock function. Off (00) / On (01)	00÷01
6B	Synchronizing Function. Off(00) / On(01)	00÷01
6C	External bus device ID	00÷99
6D	Extended hold open time function. Off (00) / On (01)	00÷01

## FUNCTION parameters

Parameter	Description	Range
67	Door type. Single sliding (00) / Biparting (01)	00=01
90 (DAS902MP)	Function select terminal 3. No function (00) / Nurse function (01) / Interlock out (03)	00=03
91 (DAS902MP)	Function select terminal 4. No function (00) / Open/Close function (01) / No function (02) / inner impulse 2 monitoring (03) / Interlock in (04)	00=04
93 (DAS902MP)	Function select terminal 2. No function (00) / Close function (01) / Inner impulse 2 (03)	00=03
99 (DAS902MP)	Function select terminal 6. No function(00) / Sustainable Disable (01)/ Enable the Mode Selector with a key (only COM500ER) (02)	00=02

## POSITION parameters

Parameter	Description	Range
11	Partial open position	00-99%
57	Low speed distance, opening	00-99cm
58	Low speed distance, closing	00-99cm

## DRIVE parameters

Parameter	Description	Range
15	Run program. Smooth (01) to max performance (05)	01=05
49	Opening max force	02=23N x10
4A	End checking closing thrust	00=23N x10
50	Closing max force	02=23N x10
64	Power supply type.150W (01) / 75W (02)	00=02
68	Door weight	00=40kg x10
69	Friction	00=99N
70	Motor type. KS200VA/HD/RG(01) / DAS200 (15) / DAS200HD-RF (16) / DAS200RG (17)	-
71	Max motor power	03=15W x10

## EMERGENCY parameters

Parameter	Description	Range
10	Emergency unit monitoring. Off (00) / Convenience monitoring (01) / Redundant monitoring (02)	00=02
36	Emergency action. Closing (00) / opening (01)	00=01
37	Emergency Action in OFF Mode. Off (00) / On (01)	00=01
38	Convenience battery. Off (00) / On (01)	00=01
40	Emergency unit test interval	04=23hours
41	Battery type. No battery (00) / 12V (01) / 24V (02)	00=02
94 (DAS902MP)	Fire impulse function terminal 18/19. Off (00) / On (01)	00=01
95 (DAS902MP)	Emergency open impulse function 5. Off (00) / On (01)	00=01
96 (DAS902MP)	Emergency button configuration 5. N.O. (00) / N.C. (01)	00=01

## LOCK parameters

Parameter	Description	Range
05	Lock configuration (main control). No lock (00 and 10) / antipanic belt lock and bistable belt lock (01) / standard belt lock (02) / antipanic (11) / standard and bistable (12)	-
06	Lock release. Off (00) / On (01)	00=01

LOCK parameters		
43	Opening delay for lock	00÷99s x0,1
44	EXIT lock. Off (00) / On (01)	00÷01
51	Push & Close. Off(00) / On (01)	00÷01
52	Push & Close Timeout	00÷99s x10
98 [DAS902MP]	Lock configuration terminal 16/17. No lock (10) / bistable (11)	10÷11

SENSOR parameters		
Parameter	Description	Range
07	Presence impulse 1 configuration. N.O. (00) / N.C. (01)	00÷01
08	Presence impulse 2 configuration. N.O. (00) / N.C. (01)	00÷01
09	Presence impulse monitoring. None(00)/sensor 1(01)/sensor 1 and 2(02)	00÷02 units
16	Inner impulse (motion) monitoring. Off (00) / On (01)	00÷01
27	Side presence input 1 configuration. N.O. (00) / N.C. (01)	00÷01
28	Side presence input 2 configuration. N.O. (00) / N.C. (01)	00÷01
29	Side presence impulse monitoring. None (00) / sensor 1 (01) / sensor 1 and 2 (02)	00÷02 units
30	Side presence activation distance	00÷99dm
31	Sensor type.1-wire (00) / 2-wire (01) monitoring	00÷01
45	STOP function. Off (00) / On (01)	00÷01
46	STOP configuration. N.O. (00) / N.C. (01)	00÷01
91 [DAS902MP]	Function select terminal 4. No function (00) / Open / Close function (01) / Interlock disable (02) / inner impulse 2 monitoring (03)	00÷04
93 [DAS902MP]	Function select terminal 2. No function (00) / Close function (01) / inner impulse 2 (03)	00÷03

OPERATION MODE SELECTOR parameters		
Parameter	Description	Range
B0	Operation mode selector variant. Electronic program selector (04)	00÷04
B1	Operation mode selector key lock. Off (00) / Hold for 2 s.(01) /Passcode (02) / key (03)	00÷03
B2	Operator mode selector service indication. Off (00) / On (01)	00÷01
B3	Choose priority of the operation mode selector. The lower the number the higher the priority.	25÷29
B4	Choose group of the operation mode selector.	00÷10
B5	Choose display mode of the operation mode selector. Show system mode (00) / Show local mode (01)	00÷01
B6	Choose terminal mode of the operation mode selector. The buttons are disabled (00) / adapts to system mode (01) / it si setting the operation mode (02)	00÷02
B7	Mode selector, self service indication. Off (00) / On (01)	00÷01
B8	Mode selector, key impulse. Disabled (00) / Login required (01) / Enabled (02)	00÷02
B9	Bluetooth Power Mode. Always disabled(00), Disabled in OFF mode(01), Always enabled (02). Default(02)	00÷02
6F	Choose group of the operation mode selector.	01÷10
97	Operation Mode Selector Function (unit DAS902MP). Off(00) / On(01)	00÷01
9A	Priority of the operation mode selector (unit DAS902MP)	25÷99
9B	Choose group of the operation mode selector (unit DAS902MP)	00÷10

## 11.2 Main control board parameters



In the "INSTALLATION SETTINGS" column you can note the modified setting values.

Parameter	Description	Factory setting	Installation setting
00	<b>High Speed Opening (10÷80cm/s)</b> Sets the maximum opening speed. (10= 10cm/s; 70= 80cm/s)	40	
01	<b>Low speed</b> <b>(05÷69= 05÷80cm/s; 70= automatic)</b> The low speed is self adjusting to optimal operation if this parameter is set to max. Depending on authority or installation requirements the low speed, distance opening and/or closing can be further reduced.	70	
02	<b>High Speed Closing (10÷80cm/s)</b> Sets the maximum closing speed. (10= 10cm/s; 70= 80 cm/s)	<b>AUTOMATIC</b>	
03	<b>Hold Open Time (00÷60s)</b> The general hold open time for inner and outer impulses.	00	
04	<b>Key Hold Open Time (00÷60s)</b> Hold open time for key impulse.	07	
05	<b>Lock Configuration (main control (00÷12))</b> <b>a) Settings for belt locks (KS200HD/RG):</b> 00= No lock. 01= antipanic belt lock KS802BLOKA and bistable belt lock KS802BLOKB 02= belt lock standard KS802BLOK <b>*NOTE:</b> The belt locks are not automatically learned. <b>b) 03-&gt;09 DO NOT USE</b> <b>c) Settings for carriages lock (DAS200/HD/RF/RG/KS200VA):</b> 10= no lock 11= antipanic lock DAS802LOKA ( locked with power -LDP) 12= standard lock DAS802LOK ( locked without power - LD) and bistable lock DAS802LOKB ( LDB) <b>*NOTE:</b> the bistable lock DAS802LOKB is not automatically learned and must be selected 12. <b>NOTE:</b> if the Configuration Tool CT is used, disable the "learn access": <input checked="" type="checkbox"/> MMI Write access <input checked="" type="checkbox"/> MMI Read access <input type="checkbox"/> Learn Access	<b>AUTOMATIC *</b>	
06	<b>Lock release (00÷01)</b> 00= Off 01= On If "LockRelease" is On the door will apply force in the closing direction when the lock is un locking. This is made to prevent a lock from being stuck in locked position when opening. <b>*NOTE:</b> If lock type is set manually (parameter 5) set 01. <b>**</b> If the Configuration Tool CT is used, disable the "learn access": <input checked="" type="checkbox"/> MMI Write access <input checked="" type="checkbox"/> MMI Read access <input type="checkbox"/> Learn Access	<b>AUTOMATIC *</b>	01 (DAS200RG/KS-200RG)
07	<b>Presence Impulse 1 Configuration (00÷01)</b> 00 = N.O. 01 = N.C.	01	
08	<b>Presence Impulse 2 Configuration (00÷01)</b> 00 = N.O. 01 = N.C.	01	

09	<p><b>Presence Impulse Monitoring (00÷02)</b>  00= No monitoring of presence impulse.  01= Set to "01" if one Presence impulse sensor shall be monitored (if only one sensor is used this sensor has to be connected to terminal 9, Presence impulse 1).  02= Set to "02" if two Presence impulse sensors shall be monitored.</p>	TO BE SET	
10	<p><b>Emergency Unit Monitoring (00÷02)</b>  The emergency unit will be tested by shutting of the power to the control panel and open the door with the emergency unit. The test is never done in operation mode selection OPEN and normally not in OFF, unless parameter 37 "Emergency Action In OFF Mode" is set to 0n, see below. Authorities can demand that the emergency unit is monitored on a regular basis, see parameter 40 "Emergency Unit Test Interval" below. Half an hour before this time has elapsed the following outer impulse generates an emergency opening test. If there is no outer impulse within the next half hour, the operator control unit generates the opening impulse by itself (ghost impulse). The test is also always performed after a Reset and after changing operation mode selection from a position where a test is not done to a position where the test is made.  00= Off.  01= Convenience monitoring. Is a simpler one-channel monitoring. Convenience monitoring can be used for monitoring battery, if the DAS901BAT1 battery is used, see parameter 43.  02= Redundant monitoring. Is a redundant two-channel monitoring that is a demand for escape route according to: EN16005 or DIN18650.  *NOTE: on DAS200RF set to 02.</p>	00*	
11	<p><b>Partial Open Position (00-99%)</b>  Sets the "winter opening" size.  NOTE: A building is certified for a certain COW. Depending on how many people that is allowed to be in the specific area there also has to be a certain opening width. Partial open position must be set to 80% of the certified distance in escape routes.</p>	50 (DAS200/KS200VA/HD)	
12	<p><b>Opening direction (00÷01)</b>  00= 1 wing Right.  01= 1 wing Left or 2 wings.  NOTE: On DAS200RG/KS200VA/HD/RG this parameter cannot be selected, the opening direction is defined with the position of the belt attachment bracket.</p>	80 (DAS200HD/RF)	
13	<p><b>Hold force (00÷60 N)</b>  Adjustment of the force used to keep the door in closed position.</p>	99 (DAS200RG/KS200RG)	
15	<p><b>Run Program (01÷05)</b>  Performance adjustment. Sets how fast or slow the door shall accelerate or break.  01= Smooth, for light doors.  05= Max Performance. For heavy doors.</p>	00 (KS200VA/HD/RG)	
		01	
		20	
		03	





16	<p><b>Inner Impulse (motion) Monitoring (00÷01)</b>  According to EN 16005 or DIN18650 it is a demand to have Inner impulse monitoring = On in escape routes.  <b>00</b>= Disables monitoring.  <b>01</b>= Enables monitoring.  <b>*NOTE:</b> on DAS200RF set to 01.  <b>**</b> If the Configuration Tool CT is used, disable the "learn access":</p> <p><input checked="" type="checkbox"/> MMI Write access <input checked="" type="checkbox"/> MMI Read access <input type="checkbox"/> Learn Access </p>	<p><b>AUTOMATIC *</b></p> <p>01  (DAS200RG/KS200RG)</p>	
20	<p><b>Partial Hold Open Time (00÷60s)</b>  Hold open time for Inner &amp; Outer impulses with operation mode selection PARTIAL and for the Nurse impulse.</p>	00	
21	<p><b>Push &amp; Go Hold Open Time (00÷60s)</b>  Hold open time after a Push&amp;Go.</p>	02	
22	<p><b>Auto Width Activation Time (00÷60s)</b>  Auto width activation time is available if parameter 61=01 "Auto Width" is selected. If the door has not closed during the auto width activation time and the door is open or opening the door will open to full open door.</p>	10	
23	<p><b>Auto Width Resume Time (00÷60s)</b>  When the door have been closed during the auto width resume time, the next opening impulse will open the door to partial open position. Only available if parameter "AutoWidth" 61=01</p>	10	
24	<p><b>Jam Hold Time (00÷10s)</b>  Sets how long time the door shall be stopped when a jam is detected during opening and also the time until the door can restart after a Stop impulse.</p>	05	
25	<p><b>Interlock Disable Time (00÷60s)</b>  The parameter controls the time that interlock is valid. Only active if "Interlock Function" parameter 6A= 01. See how interlock works in chapter 12.5.  <b>00</b>= If the time is set to 00, interlock is always active.  <b>01-60</b>= The "Interlock Disable Time" starts to count down the moment a valid opening impulse is made on the first door. If the first door does not close during the "Interlock Disable Time" the second door is not interlocked any more and will also open. When both doors are closed Interlock Disable Time will be reset.</p>	30	
26	<p><b>Presence Hold Open Time (00÷60s)</b>  Hold open time for Presence impulses 1&amp;2.</p>	02	
27	<p><b>Side Presence Input 1 Configuration (00÷01)</b>  <b>00</b>= N.O.  <b>01</b>= N.C.</p>	01	
28	<p><b>Side Presence Input 2 Configuration (00÷01)</b>  <b>00</b>= N.O.  <b>01</b>= N.C.</p>	01	
29	<p><b>Side Presence Impulse monitoring (00÷02)</b>  Side presence impulse monitoring is a demand to be activated according to EN16005 or DIN18650  <b>00</b>= No monitoring of Side Precense impulse. Set to "00" if no monitoring of Side Presence impulse sensors is required or if no Side Presence impulse sensors are installed.  <b>01</b>= Side Presence impulse 1. Set to "01" if one Side Presence impulse sensor shall be monitored (if only one sensor, it has to be connected to terminal 2, Side Presence impulse 1).  <b>02</b>= Side Presence impulse 1 and 2. Set to "02" if two Side Presence impulse sensors shall be monitored.</p>	<p><b>TO BE SET</b></p>	



2A	<p><b>Side Presence Function (00÷01)</b>  <b>00</b>= Safe Speed. If a Side Presence Impulse is activated during opening, the door shall continue to open with a safe speed (0,1 m/s).  <b>01</b>= Stop Door. If a Side Presence Impulse is activated during opening, the door shall stop and be stopped during the set Presence Hold Open Time (see parameter 26).</p>	00	
30	<p><b>Side Presence Activation Distance (00÷99dm)</b>  This is an inhibit signal for side presence.  The door will act according to the value entered in parameter 2A. The value has to be according to local legislation. In an escape route the door has to open to 80% of the certified distance (see parameter 11) within 3 sec. after an inner impulse.  <b>00</b>= If value 00 is selected side presence impulse is valid from fully closed to fully open position.  <b>01-99</b>= The distance is counted from open position. During opening, the side presence impulse is inhibited until the door reaches the entered value in the parameter.</p>	00	
31	<p><b>Sensor Type (00÷01)</b>  Select type of monitoring for the combined sensors. Choose between 1-wire (00) or 2-wire (01) monitoring.  <b>00</b>= 1-wire monitoring. 1-wire monitoring is used when combined sensors have only one monitoring input for both presence and impulse field.  <b>01</b>= 2-wire monitoring. 2-wire monitoring is used when a sensor has separate monitoring inputs for both presence and impulse field.</p>	01	
32	<p><b>Active Brake on Stop (00÷01)</b>  <b>00</b>= Off. The door will freewheel until it stops.  <b>01</b>= On. The operator will brake the doors actively during 1s on a Stop impulse.</p>	01	
33	<p><b>Push &amp; Go in EXIT and OFF Mode Selection (00÷01)</b>  <b>00</b>= Off.  <b>01</b>= On.</p>	00	
34	<p><b>Hold Force in EXIT and OFF Mode Selection (00÷01)</b>  <b>00</b>= Off.  <b>01</b>= On.  With an electromechanical lock this hold force can be unnecessary.</p>	01	
35	<p><b>Toggle Operation Mode Selector after Stop (00÷01)</b>  In operation mode selection OFF the mode must be changed before normal operation after a Stop impulse.  <b>00</b>= Off.  <b>01</b>= On.</p>	00	
36	<p><b>Emergency Action (00÷01)</b>  Fire closing/opening( ref. terminal 18-19 DAS902MP) or emergency closing/opening by battery.  <b>00</b>= Closing (The door will close on fire impulse or power failure / low battery).  <b>01</b>= Opening (The door will open on fire impulse or power failure / low battery).  <b>NOTE:</b> on DAS200RG and KS200RG this display is not visible and is set to 01.</p>	01	
37	<p><b>Emergency Action in OFF Mode (00÷01)</b>  Decides if "Emergency Action" (ref. parameter 36) shall be performed also in modes election OFF (= opens also in the middle of the night).  <b>00</b>= Off.  <b>01</b>= On.  <b>NOTE:</b> on this DAS200RG and KS200RG this display is not visible and is set to 00.</p>	00	

38	<p><b>Convenience battery 24V, DAS902BAT2 (00÷01)</b>  When this parameter is set to On (01), with a 24V (UPS) battery the operator will continue its normal operation in case of mains power failure (flat batteries: last operation= opening/closing, see parameter 36). Monitoring will be made if parameter 10 is set to Convenience Monitoring (01).  Not approved in escape routes!  00 = Off.  01 = On.  *NOTE: on DAS200RG and KS200RG this display is not visible and is set to 00.</p>	00	
40	<p><b>Emergency Unit Test Interval (04÷23hours)</b>  The time set in this parameter controls the maximum time until the next automatic test of the emergency unit is performed.</p>	23	
41	<p><b>Battery Type (00÷02)</b>  What type of battery that is mounted in the operator is identified during the Learn.  00= No battery.  01= 12V (set parameter 43= 05).  02= 24V.</p>	<p><b>AUTOMATIC</b></p> <p>*</p>	
43	<p><b>Opening Delay For Lock (00÷99s x0,1)</b>  The time the opening is delayed (0.0-9.9 sec) after an opening impulse is given in operation mode selections OFF and EXIT. If the DAS901BAT1 battery is used set parameter 43= 05.</p>	00	
44	<p><b>Exit Lock (00÷01)</b>  This parameter controls the electromechanical lock in the operation mode selector setting EXIT.  00= Off. The electromechanical lock is not locked in EXIT.  01= On. The electromechanical lock is locked in EXIT, except bistable lock.  NOTE: on DAS200RF set to 00.  NOTE: If the Configuration Tool CT is used, disable the "learn access":</p> <div data-bbox="188 850 669 898" style="border: 1px solid black; padding: 2px;"> <input checked="" type="checkbox"/> MMI Write access    <input checked="" type="checkbox"/> MMI Read access    <input type="checkbox"/> Learn Access     </div>	<p>00</p> <p>(DAS200RG / KS200RG)</p> <p>01</p>	
45	<p><b>Stop Function (00÷01)</b>  When this parameter is set to On (01) the Stop impulse is enabled, otherwise it is disabled.  00= Off.  01= On.</p>	01	
46	<p><b>Stop Configuration (00÷01)</b>  00 = N.O.  01 = N.C.</p>	01	
49	<p><b>Opening Max Force (02÷23N x10)</b>  The force applied from the operator to the door leaf during opening.  If the reopening maneuver occurs too abruptly, set parameter 49 with a value lower than the factory value (10), example 04 - 05.</p>	10	
4A	<p><b>Close Kick Force (00÷23N x10)</b>  The force applied from the operator to the door leaf during the close kick.</p>	05	
50	<p><b>Closing Max Force (02÷23N x10)</b>  The force applied from the operator to the door leaf during closing.</p>	15	





51	<p><b>Push&amp;Close (00÷01)</b>  When this parameter is set to On [01] the motor will in operation mode selections OFF or EXIT try to close the door with the force selected by parameter 50 "Closing Max Force", if someone tries to open it manually.  Push &amp; Close is also known as "poor man's lock".  00= Off.  01= On.</p>	00	
52	<p><b>Push &amp; Close Timeout(00÷99s x10)</b>  Adjustable time for how long time the door will continue to "fight back" when someone is trying to force it open.  00 = infinite time.</p>	00	
53	<p><b>Operator Type (00÷04)</b>  00= Slider.  01= DO NOT USE.  02= DO NOT USE  03= DO NOT USE  04= Mechanical Emergency Unit Slider (Sets for DAS200RF).  <b>NOTE:</b> on DAS00/DAS200RG and KS200RG this display is not visible and is set to 00.</p>	00	
54	<p><b>Service needed Operating Hours (00÷60hours x 1.000)</b>  Set time before yellow LED in operation mode selector will start flashing.</p> <p>To clear the service needed indication you have to push  on the MMI at the same time for 5 seconds when the display shows on. After 5s the display will show "SE" during another 5s., release the UP and DOWN buttons. While the display shows "SE" pres  and the Counters Operating hours will be set to zero.</p>	00	
55	<p><b>Service Needed Opening Cycles (00÷50 x 100.000)</b>  Set number of openings before yellow LED in operation mode selector will start flashing.</p> <p>To clear the service needed indication you have to push  on the MMI at the same time for 5 seconds when the display shows on. After 5 s the display will show "SE" during another 5s., release the UP and DOWN buttons. While the display shows "SE" CO pres  and the Counters Operating cycles will be set to zero.</p>	00	
57	<p><b>Low Speed Distance, Opening (00÷99cm)</b>  "Creep speed" distance during opening.</p>	40	
58	<p><b>Low Speed Distance, Closing (00÷99cm)</b>  "Creep speed" distance during closing.</p>	40	
5E	<p><b>Status indication (00÷01)</b>  The operator shows the status indication on the LED display of the control panel. See paragraph 9.2 for more information.  00= Off.  01= On.</p>	01	
5F	<p><b>Default programming (00÷01)</b>  Default programming sets the parameters to the factory default values.  00= Off (It is not possible to perform a default programming from the MMI).  01= On (It is possible to perform a default programming from the MMI).</p>	01	

60	<b>Learn (00÷01)</b> Sets the possibility to perform a learn cycle. <b>00</b> = Off (It is not possible to perform a learn cycle from MMI). <b>01</b> = On (It is possible to perform a learn cycle from MMI).	01	
61	<b>AutoWidth (00÷01)</b> If this function is selected (01) and the operation mode selection is AUTO PARTIAL. The door will open from partial open width to full open width, if an opening impulse is given and the door has not closed during the time selected in parameter 22 "Auto Width Activation Time". <b>00</b> = Off. <b>01</b> = On.	00	
64	<b>Power Supply Type (00÷02)</b> <b>00</b> = DO NOT USE. <b>01</b> = 150W. <b>02</b> = 75W.	AUTOMATIC	
65	<b>Sustainable Drive Mode (00÷01)</b> The (+) 24 V DC to accessories like sensors is turned off when the mode selector is in Off and the door is closed. Motor power is limited to 75W even if parameter 71 is set to a higher value. <b>00</b> = Off. <b>01</b> = On.	00	
67	<b>Door Type (00÷01)</b> <b>00</b> = Single sliding. <b>01</b> = Biparting. <b>NOTE:</b> If the Configuration Tool CT is used, disable the "learn access": <input checked="" type="checkbox"/> MMI Write access <input checked="" type="checkbox"/> MMI Read access <input type="checkbox"/> Learn Access 	TO BE SET	
68	<b>Door weight (00÷60kg x10)</b> Will be estimated during the Learn but can also be altered manually. <b>NOTE:</b> The weight of the door is not automatically learned on the DAS200RF, it must be set manually. <b>NOTE:</b> If the Configuration Tool CT is used, disable the "learn access": <input checked="" type="checkbox"/> MMI Write access <input checked="" type="checkbox"/> MMI Read access <input type="checkbox"/> Learn Access 	AUTOMATIC (not on DAS200RF)	
69	<b>Friction (00÷99N)</b> The friction when moving the door is automatically measured during a Learn. <b>NOTE:</b> DAS200 not more than di 50N. <b>NOTE:</b> DAS200HD/RF/RG not more than 70N.	AUTOMATIC	
6A	<b>Interlock Function (00÷01)</b> It is necessary plus module DAS902MP <b>00</b> = Off <b>01</b> = On See example of connection at chapter 12.	00	
6b	<b>Synchronizing Function (00÷01)</b> Interconnection cable needed. <b>00</b> = Off <b>01</b> = On See example of connection at chapter 12.	00	
6c	<b>External Bus Device ID (00÷99)</b> In a chain of interconnected operators one of them has to be the main operator. This operator shall have the value 01. All other interconnected operators shall have different values in this parameter. This to make every operator unique.	01	

6d	<b>Extended Hold Open Time Function (00÷01)</b> + 5s hold open time on doors often reopening during closing. 00= Off. 01= On.	00	
6F	<b>Control unit electronic mode selector group (01÷10)</b> This parameter groups MCU with OMS. Units with the same value are in the same group. Units in the same group listens to each other. <b>NOTE:</b> function not available, do not modify factory setting. FUTURE USE.	01	

### MOTOR CONTROL PARAMETERS

Parameter	Description	Factory setting	Installation setting
70	<b>Motor Type</b> 01= KS200VA/HD/RG 15= DAS200 16= DAS200HD / DAS200RF 17= DAS200RG	FACTORY SET	
71	<b>Max Motor Power (03÷15)</b> The max amount of power the motor can be supplied with.	15	

### DAS902MP PLUS MODULE PARAMETERS

Parameter	Description	Factory setting	Installation setting
90	<b>Function Select terminal 3 - DAS902MP (00÷03)</b> 00= NO FUNCTION. 01= Nurse function. The door will open to partial opening in operation mode selections EXIT, AUTO and AUTO PARTIAL. 02= DO NOT USE. 03= Interlock out. When configuring for interlock also set parameter 6A= 01.	01	
91	<b>Function Select terminal 4 - DAS902MP (00÷04)</b> 00= NO FUNCTION. 01= Open/Close Function. One impulse opens the door the next impulse closes the door. Available in operation mode selections EXIT, AUTO, PARTIAL. 02= NO FUNCTION. 03= Inner impulse 2 monitoring. Sets inner impulse 2 monitoring for the second inner impulse on the DAS902MP unit. Set also parameter 93= 03. 04= Interlock in. When configuring for interlock also set parameter 6A= 01.	01	
92	<b>Open/Close Timeout, terminal 4 - DAS902MP (00÷60 minutes)</b> The time set in this parameter controls when a door shall start closing automatically if left open by an Open/Close impulse. 00 min= no automatic closing.	15	
93	<b>Function Select terminal 2 - DAS902MP (00÷03)</b> 00= No function. 01= Close function. This impulse will immediately close the door, even during opening, and remain closed as long as the Close impulse is active. The electro-mechanical lock will lock the closed door. May not be used on an escape route door. 02= DO NOT USE. 03= Inner impulse 2. When two inner impulses are to be used. Sets input to inner impulse 2.	01	
94	<b>Fire Impulse Function, terminal 18-19 - DAS902MP (00÷01)</b> Depending on configuration in Emergency Action (36), the door will open or close on fire impulse. Fire impulse override presence impulse. At closing, the door will not reopen on jam. 00= Off. 01= On.	00	

95	<b>Emergency Open Impulse Function, terminal 5 - DAS902MP (00÷01)</b> Fireman's opening and for DAS200RF. 00= Off. 01= On.	01	
96	<b>Emergency Open Impulse Configuration, terminal 5 - DAS902MP (00÷01)</b> Configures the button used for Fireman's opening. 00= N.O. 01= N.C.	01	
97	<b>Operation Mode Selector Functio, terminal 9÷14 - DAS902MP (00÷01)</b> Switch / timer / relay 00= Off. 01= On (Not allowed in escape route, according to EN16005 and DIN18650).	00	
98	<b>Lock Configuration, terminal 16-17 - DAS902MP (10÷11)</b> Bi-stable lock used as night lock of escape routes. <b>a) Settings for belt locks (KS200HD/RG):</b> 00= No lock. 01= bi-stable belt lock KS802BLOKB <b>b) 03-&gt;09 DO NOT USE</b> <b>c) Settings for carriages lock (DAS200RF/RG):</b> 10= No lock. 11= Bi-stable lock DAS802LOKB( LDB)	10	
99	<b>Function Select, terminal 6 - DAS902MP (00÷02)</b> 00= No function. 01= Disables Sustainable drive mode. It is possible to disable sustainable drive mode. As long as contact is active the operator will run with full power. 02= Enable the Mode Selector with a key (only COM500ER). DAS909MP mode selector and all other Mode Selectors are not affected by this parameter. When parameter is set to value 02 the OMS is locked. If an impulse is given on IOU TB:6 the indication LED on OMS will be steady red during 15 seconds and it is possible to change mode selection (set parameter B1=00). <b>NOTE:</b> After the adjustment of this parameter, if a learning cycle is not carried out (by pressing LEARN for more than 2s.), disconnect and reconnect the main power supply and batteries.	00	
9A	<b>Priority of the operation mode selector DAS902MP, teminals 9÷14 (25÷99)</b> The lower the number is the higher the priority. <b>NOTE:</b> function not available, do not modify factory setting. FUTURE USE.	30	
9b	<b>Choose group of the DAS902MP operation Mode selector, terminals 9÷14 (00÷10)</b> This controls which MCU that looks at which OMS. MCU and OMS with same group number listens to each other. If value 00 is selected the DAS902MP mode selector controls all operators. <b>NOTE:</b> function not available, do not modify factory setting. FUTURE USE.	01	
<b>ELECTRONIC OPERATION MODE SELECTOR PARAMETERS</b>			
Parameter	Description	Factory setting	Installation setting
60	<b>Operation mode selector variant (01÷04)</b> 01= DO NOT USE. 02= DO NOT USE. 03= DO NOT USE. 04= ELECTRONIC SELECTOR.	<b>AUTOMATIC</b>	

### Operation mode selector key lock (00+03)

COM501ES/ER COM502ES/ER



There are four different levels of access code choices for the operation mode selector.

### COM500ES/ER

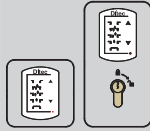

There are three different levels of access code choices for the operation mode selector.

**00**= No access code (Not allowed in escape route, according to EN16005 and DIN18650).

**01**= Hold for two sec (Not allowed in escape route, according to EN16005 and DIN18650).

**COM500ES**, access is obtained by holding ▲ or ▼ for 2 seconds.

**COM501ES, COM502ES**, access is obtained by holding any mode selection button for 2 seconds.

**02**= Passcode.

**COM500ES**, passcode can be selected where the access is obtained by briefly pushing in turn ▲▲▲▲▲.

The entire passcode must be entered within 3 seconds (Not allowed in escape route, according to EN16005 and DIN18650).

**COM501ES, COM502ES**, passcode can be selected where the access is obtained by briefly pushing the buttons in correct order.

The entire passcode must be entered within 10 seconds. The passcode can be changed through the DAS900CT.

Default passcode is 

**03**= Key.

**COM501ER, COM502ER**

To enable the use of the selector, rotate the key clockwise towards the symbol .

**COM500ER**

mode selector is not affected by this parameter.

See parameter 99.

61

00

### Operator mode selector service indication (00+01)

Yellow flashing service LED.

Service indication on operation mode selector.

No service indication (00). Indicate service (01).

**00**= Off

**01**= On

62

01

### Choose priority of the operation mode selector (25+99)

The lower the number the higher the priority.

**NOTE:** function not available, do not modify factory setting. FUTURE USE.

63

40

64	<p><b>Choose group of the operation mode selector (00÷10)</b>  This controls which MCU that looks at which OMS. It is possible to group different OMS to different MCU. MCU and OMS with same group number listens to each other. If a OMS is set to 0 this OMS controls all operators that is connected in that loop.  <b>NOTE:</b> function not available, do not modify factory setting. FUTURE USE.</p>	01	
65	<p><b>Choose display mode of the operation mode selector (00÷01)</b>  In Show local mode the OMS shows the last setting made on the OMS.  In Show system mode the OMS shows the setting that the operator is put to. It is shown with one flash every 5s.  When the OMS is flashing every 5s it is not possible to change the mode on the OMS.  <b>00</b>= Show system mode.  <b>01</b>= Show local mode.</p>	AUTOMATIC	
		00 (COM501ES/ER-COM502ES/ER)	
		01 (COM500ES/ER)	
66	<p><b>Choose terminal mode of the operation mode selector (00÷02)</b>  <b>00</b>=The buttons on OMS are disabled.  <b>01</b>= The OMS adapts to system mode.  <b>02</b>= The OMS keeps its selected mode.</p>	AUTOMATIC	
		01 (COM501ES/ER-COM502ES/ER)	
		02 (COM500ES/ER)	
67	<p><b>Mode selector, self service indication 00÷01)</b>  <b>COM500ES/ER.</b> Orange flashing service LED.  <b>COM501ES/ER, COM502ES/ER.</b> Magenta flashing service LED.  Self service indication on operation mode selector.  <b>00</b>= Off. No self service indication.  <b>01</b>= On. Indicate self service. Indicating a status or condition that can be cleared by the owner e.g. a break-out door is standing open.</p>	01	
68	<p><b>Mode selector, key impulse (00÷02)</b>  If the selector is set on CLOSED DOOR, key impulse to the operator can be made in the following ways by pushing the symbol below.  <b>COM500ES/ER,</b> ▼</p> <div data-bbox="445 1034 490 1082" style="display: inline-block; border: 1px solid black; padding: 2px; text-align: center;">   CLOSE </div> <p><b>COM501ES/ER, COM502ES/ER</b></p> <p><b>00</b>= Disabled. Disables the possibility to give key impulse.  <b>01</b>= Login Required. Login required on the OMS to enable the possibility to give key impulse.  The login is configured through parameter 99 and B1.  <b>02</b>= Enabled. Enables the possibility to always give key impulse.</p>	00	
69	<p><b>Bluetooth Power Mode (00÷02)</b>  <b>COM501ES/ER, COM502ES/ER.</b>  <b>00</b>= Always disabled. The Bluetooth Power Mode is fully disabled until other mode is set.  <b>01</b>= Disabled in OFF mode. The Bluetooth Power Mode is disabled in OFF mode.  <b>02</b>= Always enabled. The Bluetooth Power Mode is fully enabled until other mode is set.</p>	02	



Parameters from C0 to C9= FUTURE USE.

# 12. Example of connection

## 12.1 Combined opening and safety sensor + safety sensor on opening



The electrical connections must be made when the mains power supply is switched off.

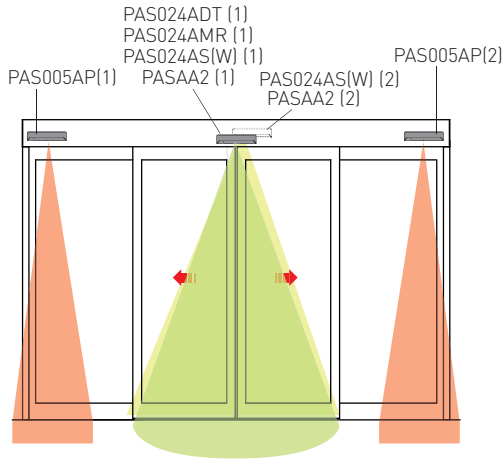

With these connections, the automation opens and makes a reversal safety contact on the passage opening with a command from the internal and/or external sensor.

Opening safety is guaranteed by the auto-control side sensors.



**NB:** If only one sensor is connected, refer to the sensor connections [1].



**ATTENTION:** if the sensor is connected to the terminals of the control unit as shown below and not to the dedicated plugs, as indicated in chapter 8.1, DO NOT cut this cable side that must be connected to the SENSOR:

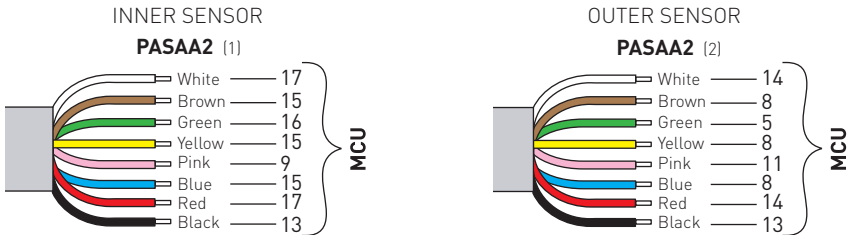
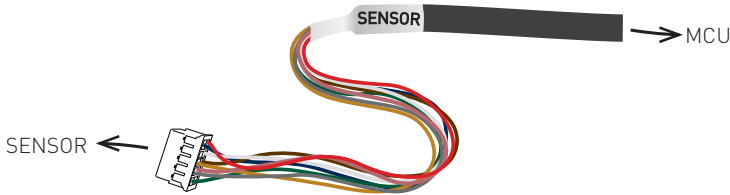

Set the selection DIP switches on sensor PASAA2 as shown below:



IP2266EN

**INNER SENSOR  
PAS024AS(W) (1)**

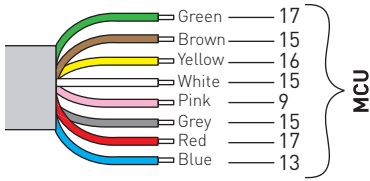

**OUTER SENSOR  
PAS024AS(W) (2)**

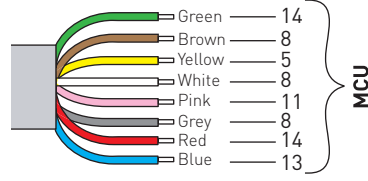

**SIDE SENSOR  
PAS005AP (1)**

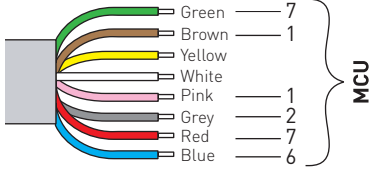

**SIDE SENSOR  
PAS005AP (2)**

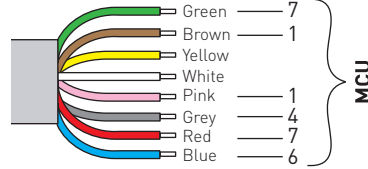

**INNER SENSOR (sensor 1)  
PAS024ADT (1)**

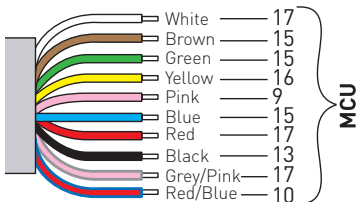

**SECONDARY INNER IMPULSE MONITORING  
INNER SENSOR (sensor 2)  
PAS024ADT (1)**

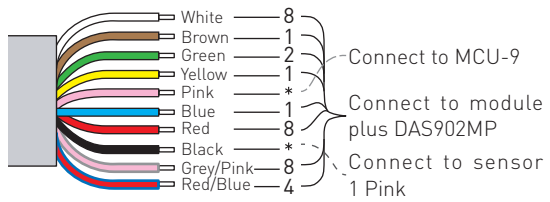

MCU Config parameters to be set to **91= 3** and **93= 3**.

Set the selection DIP switches on sensor PAS024ADT as shown below:



**INNER SENSOR (sensor 1)  
PAS024AMR (1)**

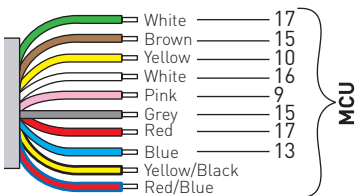

**SECONDARY INNER IMPULSE MONITORING  
INNER SENSOR (sensor 2)  
PAS024AMR (1)**

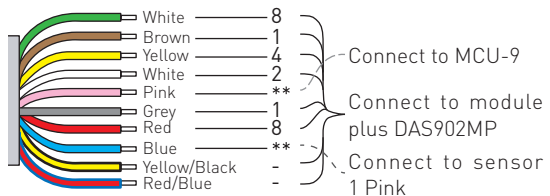

MCU Config parameters to be set to **91= 3** and **93= 3**.

**i** For more information on sensors, refer to the relevant installation manuals.



## 12.2 Interconnection of operators

### 12.2.1 Interconnection cable

Interconnection cable is used for controlling several operators with one operation mode selectors (OMS) and for synchronization. Operators can communicate with each other by connecting an interconnection cable between the operators.

Cable connection:

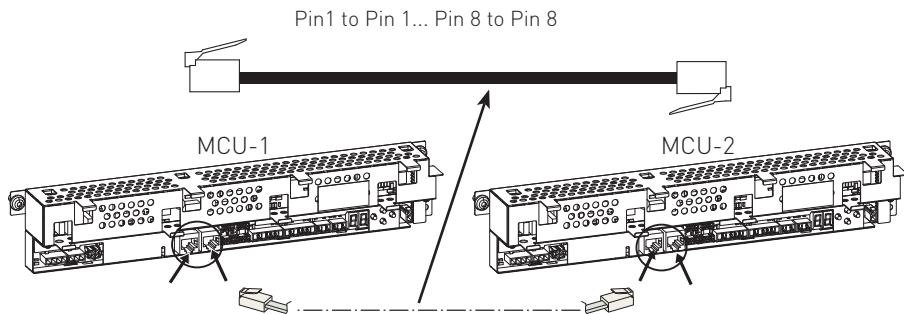

### 12.2.2 Hardware configuration for interconnection

When interconnecting more than two units (MCU and operation mode selector (OMS)) to the external bus, only the two end units must be terminated. To make this, the jumper JMP shall be removed from the middle MCU. When the jumper is removed the termination is removed.

Maximum 2 MCU can be interconnected together with 1 OMS.

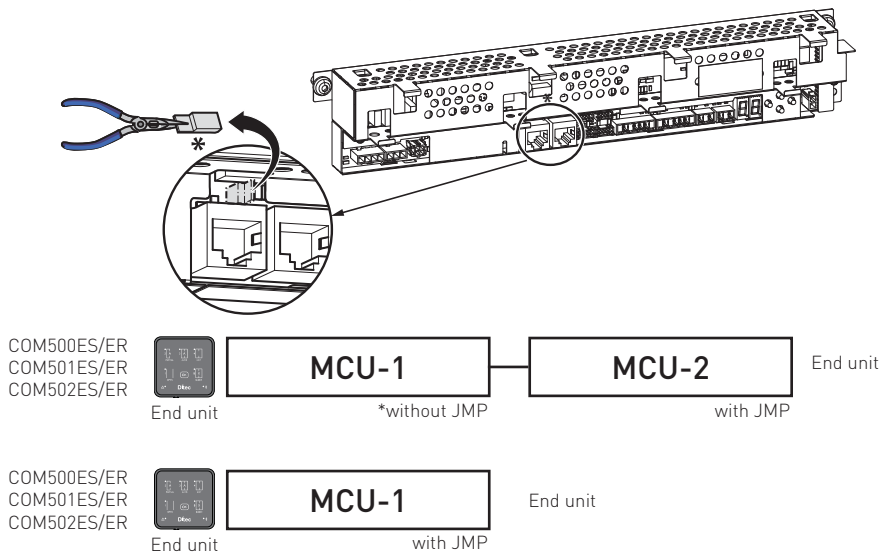

Total maximum cable length is 500m. Use a straight-through shielded twisted pair (STP/FTP) CAT5/ CAT5e cable if the length exceeds 30m or is in electrically disturbing environment.

### 12.2.3 Parameter configuration for interconnection

**i NOTE:** Do not connect the operation mode selector (OMS) before the configuration of 6C is done on all MCUs.

One of the operators has to be the main MCU (MCU-1). The main MCU shall have the value 01 in parameter 6C. The other interconnected operator shall have ascending values in parameter 6C. When the configuration is done break the power on all the interconnected operators. Connect the OMS, turn on the power. The main MCU is the control unit that holds the parameters to the operation mode selector (OMS).

### 12.3 Operation mode selector (OMS) functionality

Check how to install interconnected units before configuring the operation mode selector (OMS). See section 12.4.

All functionality regarding the operation mode selector (OMS) is programmed through the MMI on the main MCU-1 (has parameter 6C= 01).

There are three (3) different types of configurations for MCU and OMS.

The "configure parameter" shows which parameter to change from the default setting to obtain the function described, the parameters in the parenthesis shall represent the default values.

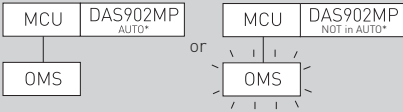
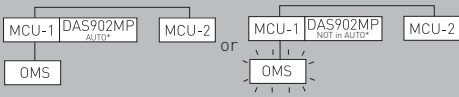
1	<p>Single control</p> 	<p>One MCU and one OMS. MCU is controlled by the OMS Configure parameter MCU, <b>b5=0, b6=1 (6F=01, b3=40, b4=01)</b>.</p>
2	<p>Single control with DAS902MP unit override</p> 	<p>One MCU with DAS902MP and one OMS. OMS controls MCU when DAS902MP is in AUTO. When DAS902MP is not in AUTO, DAS902MP controls MCU and OMS shows active mode selection. OMS is flashing once every 5 second to show that it is remotely overridden. When the OMS is remotely overridden it is not possible to change its mode. Configure parameter MCU, <b>97=01, b5=0, b6=1, (6F=01, 9A=30, 9b= 01, b3=40, b4=01)</b>.</p>
3	<p>Local paired, single control with DAS902MP unit override</p> 	<p>Two MCU, one OMS and one DAS902MP connected to MCU-1. OMS controls MCU-1 and MCU-2 when DAS902MP is in AUTO. When DAS902MP is not in AUTO, DAS902MP controls both MCU-1 and MCU-2. OMS is flashing once every 5 second to show that it is remotely overridden. When the OMS is remotely overridden it is not possible to change its mode. Configure parameter MCU-1, <b>97=01, b5=0, b6=1, (6C=1, 6F=01, 9A=30, 9b=1, b3=40, b4=01)</b>. Configure parameter MCU-2 <b>6C=2, (6F=1)</b>.</p>

- **AUTO**= no use of terminals 9 ÷ 15 of plus module DAS902MP;
- **Not in AUTO**= use of terminals.

## 12.4 Synchronization

Synchronization is when two operators work together. The doors opens and closes at the same time. A typical use is when two big single sliders are put together to get one big clear opening width. Synchronized can only be done between two operators, not more.

For synchronization:

- set parameter **6b**= 01 on all MCUs;
- set parameter **6c**= 01 on MCU-1 ( main MCU);
- set parameter **6c**= 02 on MCU-2.

**i** **NOTE:** Do not connect the operation mode selector (OMS) before the configuration of 6C is done on all MCUs.

When the configuration is done break the power on all the interconnected operators. Connect the OMS, turn on the power. The main MCU is the control unit that holds the parameters to the operation mode selector (OMS). Make a reset after adjustment.

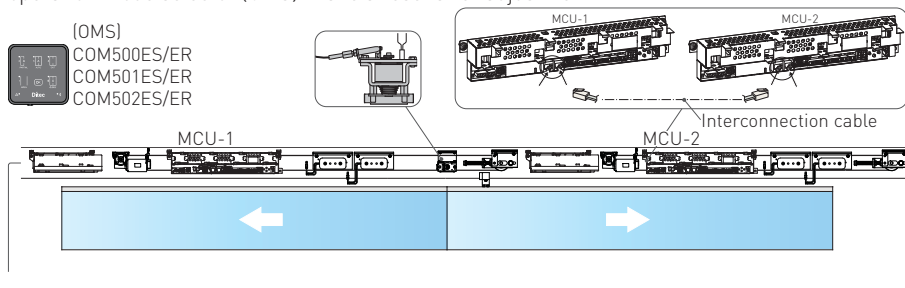

## 12.5 Interlock

Do not use interconnection cable, for connection ref. fig. 1

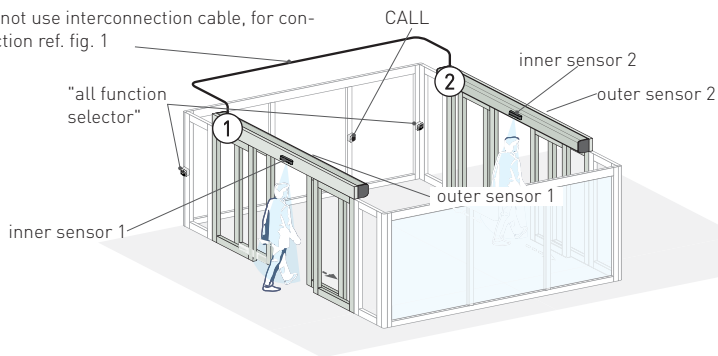

When operators are interlocked only one door can open at the time. The open door must close before the other door can open. For instance from the start: both doors are closed. If door 1 gets an impulse this door opens. If door 2 also gets an impulse before door 1 has closed, door 2 will stay closed. When door 1 has closed door 2 will open. It is not necessary for door 2 to get another impulse for the door to open, the first impulse is remembered and will open the door. A typical use of this function is an air lock to reduce draft and energy loss in an entrances.

**i** **NOTE:** it cannot be used as a security interlock.

**NOTE:** the best solution is to install an intercommunication system or an emergency call button ( CALL) on the inside, between the two doors.



The electrical connections must be made when the mains power supply is switched off.

MCU

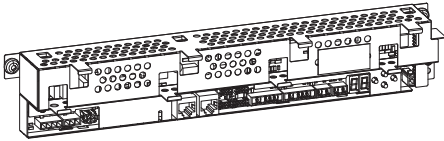

Do not use interconnection cable, for connection ref. fig. 1

Set the following parameters in all MCUs:

- 6A= 01 Interlock function;
- 90= 03 Interlock out;
- 91= 04 Interlock in.

After adjustment press the LEARN button for 2 seconds, the display flashes **L**.

See parameter 25 for Interlock disable time

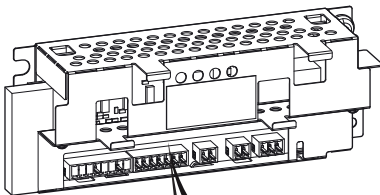
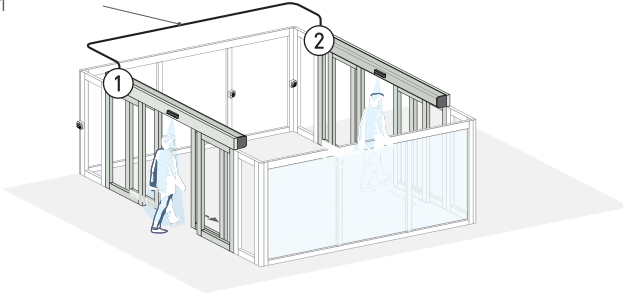

DAS902MP operator 1

DAS902MP operator 2

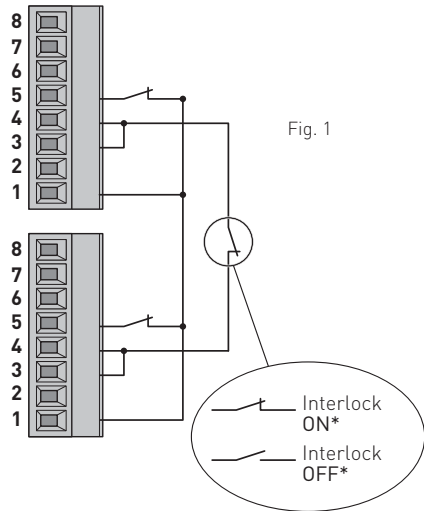

\* a function selector must be connected to each MCU to manage the status of each operator individually which overrides / disables the interlock operation.

# 13. Troubleshooting

Problem	Solution
The automation doesn't open and the motor doesn't start up	Check and change the functions selector switch settings.
	Make sure there are no objects on the sensor's detection path.
	Check the power supply switch inside the building.
The motor starts up but the automation doesn't open	Check any locks, releasing them if necessary.
	Make sure there are no objects hindering the opening of the automation.
The automation doesn't close	Check and change the functions selector switch settings.
	Make sure there are no objects on the sensor's detection path.
The automation opens and closes by itself.	Make sure there are no moving elements on the sensor's detection area.
The reopening maneuver occurs too abruptly	Set parameter 49 with a lower value , example 04-05

Before starting the troubleshooting, check that the operation mode is correctly selected. Start the troubleshooting by checking the mechanical and electrical parts of the operator in the order listed below.

The electromechanical parts are fixed in the support beam. To replace these components, the complete unit has to be loosened and replaced.

- a. The main control unit is equipped with a two digit display for error indication.
- During normal operation the display shows .
  - If all segments are off in the display check the mains power, power supply cable or perform a RESET. If the problem remains replace the main control unit or the power supply.
  - When an error is active the display is alternating between an error type e.g. E4 (Motor / En-coder Error) and a second two digit number specifying the error more in detail e.g. 03 (en-coder error). If several errors are active they will be displayed in sequence. On each electronic unit there is also a green light emitting diode (LED). If the LED is off or flashing it is indicating that this unit is failing.

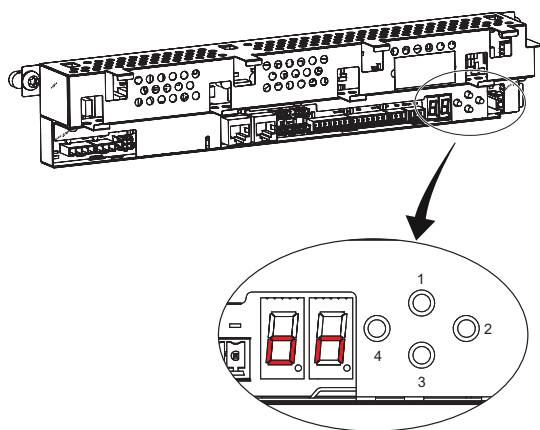

1. **(UP)**: to step up in parameter or value menu.
2. **(SELECT)**: enters into parameter or value menu and program a value into memory.
3. **(DOWN)**: to step down in parameter or value menu.
4. **(LEARN/EXIT)** (LEARN) has 3 functions:
  - 1 quick learn,
  - 2 Normal learn,
  - 3 default setting; EXIT jumps out from value menu without saving or parameter menu.

- b. Disconnect the mains power and batteries, if fitted. Unlock all mechanical locks. Pull the door leaf manually and check that the door can be easily moved over the complete sliding track/floor guide. If the door leaf stops or is hard to move, the reason may be sand, stones, rubbish etc. in the floor guide.

The door leaf may also be jamming on the floor or on the weather proofing brush strips. Clean the floor guide, adjust the door leaf height/depth or take other necessary measures e.g. replacement of worn parts until the door leaf is running smoothly when manually operated.

- c. Check that there is the right belt tension (ref. paragraph 7.3).

## 13.1 Activ error indication

**E1 - E8**= flashing letter E followed by a digit displays an active error (1-8). The digit shows the main type of error. The display switches between this main error and a two digit number to specify the error.

If several errors are active they are displayed in a sequence. Errors are cleared by a RESET from the operation mode elector (OMS) or by turning off and on the mains power.

### DEFINITIONS:

**OMS**= operation mode selector.

**I/O**= plus module DAS902MP.

**MCU**= control panel.

**PSU**= power supply unit.

Main error: Power Supply		
Detailed error	Reason	Remedy
- - Not enough power	There is not enough power to the MCU.	Check that the power does not drop from the PSU, check cables. Replace the PSU.

Main error: E1 Sensor Error		
Detailed error	Reason	Remedy
<b>19</b> Inner Impulse Error	The control unit does not get a test answer from the activation unit.	Make sure that the monitoring output is connected and the connections are OK. Replace the monitored inner activation unit.
<b>20</b> Fire Impulse Error	The control unit does not get a test answer from the fire alarm.	Make sure that the fire alarm connections are OK.
<b>28</b> IOU Inner impulse 2 error	The control unit does not get a test answer from the activation unit.	Make sure that the monitoring output is connected and the connections are OK. Replace the monitored inner activation unit.
<b>29</b> Outer Impulse Error	The control unit does not get a test answer from the activation unit.	Make sure that the monitoring output is connected and the connections are OK. Replace the monitored outer activation unit.
<b>30</b> Stop Impulse Error	The control unit does not get a test answer from the stop impulse.	Make sure that the monitoring output is connected and the connections are OK.
<b>31</b> Side Presence Impulse Error	The control unit does not get a test answer from the activation unit.	Make sure that the monitoring output is connected and the connections are OK. Replace the side presence activation unit.
<b>32</b> Presence Impulse Error	The control unit does not get a test answer from the activation unit.	Make sure that the monitoring output is connected and the connections are OK. Replace the side presence activation unit.

Main error: E2 Emergency Unit Error		
Detailed error	Reason	Remedy
<b>21</b> Emergency Unit Error	The battery voltage drops due to low capacity during test. The battery voltage measurement is wrong.	Charge or replace the battery. Replace the escape route unit (if present), otherwise replace the main control unit.

<b>25</b> Battery Error	The battery is disconnected, short circuited or the internal thermal fuse in the battery is defective. The charging current is out of specification.	Make sure that the cables are OK and connected. Charge or replace the battery. Replace the main control unit.
<b>26</b> Emergency Action Timeout	The door is prevented its emergency unit test within a stated time, due to high friction or jammed door.	Make sure that the door can open to the fully open position.

### Main error: E3 Electronic Unit Error

Detailed error	Reason	Remedy
<b>00</b> RAM Error	Internal RAM memory error.	RESET, and if the problem remains, replace the electronic unit having a flashing or extinguished LED.
<b>01</b> ROM Error	Internal ROM memory error.	RESET, and if the problem remains, replace the electronic unit having a flashing or extinguished LED.
<b>02</b> EEPROM Error	Serious internal EEPROM memory error.	RESET If the problem remains, replace the main control unit
<b>05</b> Ambient Temperature Error	Ambient temperature measurement is wrong.	RESET, and if the problem remains, replace the main control unit.
<b>06</b> Brake Chopper Error	Not possible to activate brake chopper.	RESET, and if the problem remains, replace the main control unit.
<b>08</b> A/D Converter Error	The internal A/D converter is broken.	RESET, and if the problem remains, replace the electronic unit having a flashing or extinguished LED.
<b>10</b> Register Error	Internal register error..	RESET, and if the problem remains, replace the electronic unit having a flashing or extinguished LED.
<b>11</b> OS Error	Internal program error.	RESET, and if the problem remains, replace the electronic unit having a flashing or extinguished LED.
<b>14</b> Lock Current Error	The lock is defective.	Check that the right lock is installed, and if the problem remains, replace the lock. RESET, and if the problem remains, replace the main control unit.
<b>17</b> Hardware Watchdog Error	It is not possible to disable the motor bridge.	RESET, and if the problem remains, replace the main control unit.
<b>18</b> EEPROM Critical Write Error	Internal write EEPROM memory error. This error mainly occurs when it is impossible to change a configuration parameter.	RESET, and if the problem remains, replace the main control unit.
<b>22</b> 24 V Over Current Error	The auxiliary 24 V output is overloaded.	RESET, and if the problem remains, check the connected sensors and other 24 V accessories. RESET, and if the problem remains, replace the electronic unit having a flashing or extinguished LED.
<b>23</b> Lock Circuit Error	It is not possible to disconnect the lock with the lock relay.	RESET, and if the problem remains, replace the main control unit.
<b>24</b> Learn Error	The Learn cycle has timed out.	Make sure that the door can make a full open/close cycle. Check for high friction or jammed door and then make a new Learn.

<b>27</b> bistable ( LDB) lock error	The LDB lock is defective.	Check that the right lock is installed; if the problem remains, replace the lock.
<b>33</b> Flash Code Error	Serious internal programming error.	RESET, and if the problem remains, replace the main control unit.
<b>34</b> Output Enable Error	Test of safety related circuits failing.	RESET, and if the problem remains, replace the main control unit.
<b>35</b> Link Voltage Error	The internal link voltage measurement is wrong.	RESET, and if the problem remains, replace the main control unit.
<b>46</b> OMS Internal Error	Internal error in the OMS.	RESET, and if the problem remains, replace the OMS.

### Main error: E4 Motor / Encoder Error

Detailed error	Reason	Remedy
<b>03</b> Encoder Error	The encoder, encoder cable, or motor cable is damaged.	Make sure that the encoder cable and the motor cable are connected.
	Wrong motor type is selected.	Check Motor Type configuration.
<b>04</b> Motor Current Error	The motor cable or the encoder cable is damaged.	Make sure that the encoder cable and the motor cable are connected.
	Wrong motor type is selected.	Check Motor Type configuration.
<b>09</b> Encoder Cable Error	The encoder cable is damaged.	Make sure that the encoder cable is connected, otherwise replace the encoder cable.

### Main error: E5 Lock Error

Detailed error	Reason	Remedy
<b>07</b> Lock Failure	The lock or something else was preventing the door from opening the first 14 mm from closed position.	Make sure that the lock is operating without friction.
		Make sure that Hold Force and Lock Release parameters are set correctly.

### Main error: E6 Communication Error

Detailed error	Reason	Remedy
<b>12</b> Motor Control Communication Error	Motor control processor disconnected from the internal bus.	RESET, and if the problem remains, replace the main control unit.
<b>13</b> Door Control Communication Error	Door control processor disconnected from the internal bus.	RESET, and if the problem remains, replace the main control unit.
<b>36</b> Escape Route Communication Error	Escape route unit processor disconnected from the internal bus.	RESET, and if the problem remains, replace the escape route control unit.
<b>37</b> I/O Communication Error	I/O control unit disconnected from the internal bus.	RESET, and if the problem remains, replace the I/O control unit.
<b>38</b> I/O Brand Mismatch Error	The I/O control unit is not of the brand Ditec.	Replace the I/O control unit with a I/O control unit of the brand Ditec
<b>39</b> OMS Brand Mismatch Error	The Operation mode selector (OMS) is not of the brand Ditec.	Replace the Operation mode selector (OMS) with a OMS of the brand Ditec.
<b>47</b> OMS Communication Error	Corrupted communication with the OMS when selecting operation mode.	RESET, and if the problems remains change the OMS. If the problem still remains after changing the OMS change the MCU.
<b>51</b> Web Communication Error	Web control unit disconnected from the internal bus.	RESET, and if the problem remains, replace the Web control unit.
<b>52</b> Hi-O Communication Error	Web Hi-O unit disconnected from the internal bus.	RESET, and if the problem remains, replace the Hi-O control unit.



<b>53</b> Operation Mode Selector Communication Error	Operation mode selector (OMS) disconnected from the external bus.	RESET, check connections, and if the problem remains, replace the operation mode selector (OMS).
<b>54</b> External Communication Error	The external bus is malfunctioning.	RESET, and if the problem remains, replace the main control unit.
<b>55</b> CTI Brand Mismatch Error	The Configuration Tool Interface (CTI) or the MCU is not of the Ditec.	Check that the operator is a Ditec operator.



It is not possible to replace an Ditec operator component with a component from a different brand.

### Main error: E7 Motor Temperature High

Detailed error	Reason	Remedy
<b>16</b> Motor Temperature High	The duty cycle of the door is too high for the current Speed settings and Hold Open Time.	If the motor is warm, put the door in operation mode OPEN and wait for at least 1 minute. Reduce Speeds and increase Hold Open Time parameters.
	The heavy-duty motor is replaced by a normal duty motor.	Put the door in operation mode selection OPEN and wait for at least 5 minutes.

### Main error: E8 Non-critical Error

Detailed error	Reason	Remedy
<b>49</b> EEPROM Non-critical Write Error	The main control unit cannot write error log or event log information to the EEPROM memory.	RESET, and if the problem remains, replace the main control unit if it is important to read logged information.
<b>50</b> EEPROM Access Error	The EEPROM queue is full.	Too many Events to log. Reduce the number of events to log in the Event Log configuration.

### OMS Error Codes

Detailed error	Reason	Remedy
Red light every 2 seconds	Error in door operator MCU.	RESET, and if the problem remains a service visit is required.
Red light 4 times per second	Internal error in the OMS.	Replace the OMS.

After remedy or replacement the operator has to be checked as follows:

- a. Study the door movement and adjust the functions to the values required for a smooth door operation and make sure to complete with local regulations.
- b. Check that correct functions and values have been selected for the installed accessories and that the installation complies with valid regulations and requirements from the authorities.
- c. Clean the cover and the doors.

# 14. Routine maintenance plan

Perform the following operations and checks every 6 months, according to the intensity of use of the automation.

With power supply and batteries disconnected:

- Clean and lubricate the mobile parts (the carriage slide guides and the floor guides).
- Check the belt and its tension.
- Clean sensors.
- Check the stability of the automatic system and make sure that all screws are correctly tightened.
- Check the alignment of the door wings, the position of the end stops, and the correct introduction of the blocking device.

With power supply and batteries connected:

- Check the blocking system is working correctly.
- Check the stability of the automation, and make sure it moves smoothly.
- Check that all control functions are operating correctly.
- Make sure the command and safety sensors are working correctly.
- Make sure the forces developed by the automation meet the requisites of the applicable regulations.
- Check the correct functioning of the batteries.



**NB:** for spare parts, see the spares price list.



Only use original spare parts for repairing or replacing products.

The installer must supply all information concerning the automatic, manual and emergency operation of the motorised automation or gate, and must provide the user with the operating instructions.

The installer must prepare and keep a maintenance record showing all the routine and extraordinary maintenance work carried out.

All the rights concerning this material are the exclusive property of ASSA ABLOY Entrance System AB. Although the contents of this publication have been drawn up with the greatest care, ASSA ABLOY Entrance System AB cannot be held responsible in any way for any damage caused by mistakes or omissions. We reserve the right to make changes without prior notice.

Copying, scanning or changing in any way is expressly forbidden unless authorised in writing by ASSA ABLOY Entrance System AB.

